

MICROCONE

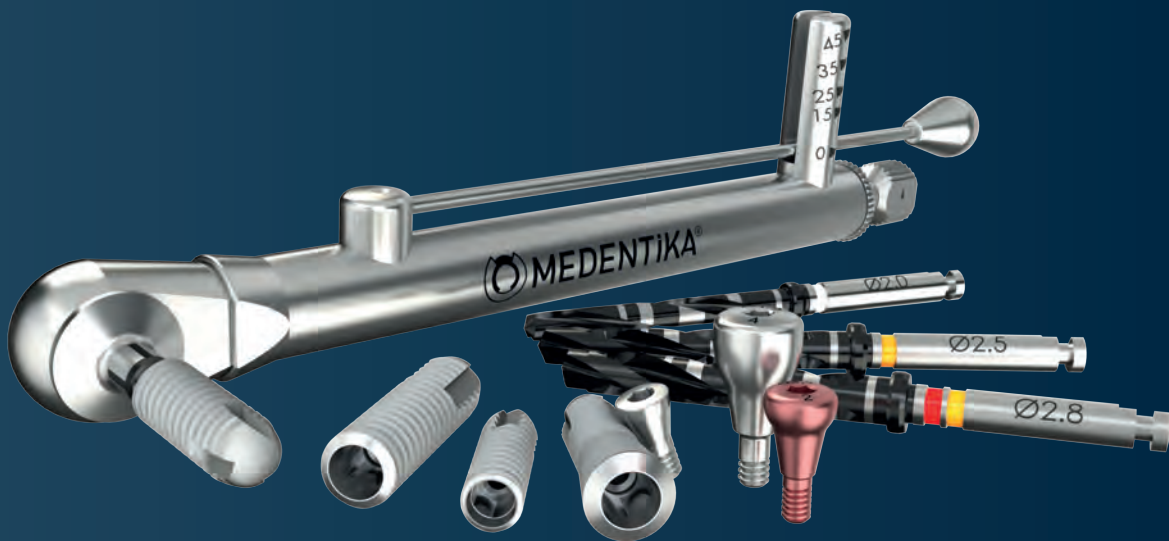

IPS

IMPLANT SYSTEMS

MICROCONE

Catalog 2021/22

Thank you for your trust



System description

The MICROCONE implant	4
Color coding	6
Diameters and lengths	6
Gingiva former	7
Drill	8
Drill stops	10
MedentiGuide - The computer-aided treatment	12
Surgical tray	14
Surgical tray layout diagram	16
The surgery washing tray	18
Surgery washing tray layout diagram	20
The new implant packaging	22
The new placement instrument	24
Torque ratchet surgical	24
Implant removal	25
Drilling protocol	26
Implantation step-by-step	27
Implant bed preparation	27
Implant insertion	28
Option 1: Transgingival healing	29
Option 2: Submerged healing	30
Option 3: Immediate restoration with a provisional	31
Prosthetic concept	32
Continuity of the emergence profile	32

Product catalog

Surgery	34
Prosthetics	60
Prosthetic tools	82
Accessories	85

The MICROCONE implant

High precision conical implant abutment connections

EMERGENCE PROFILE

The natural forming of the prosthetic emergence profile is an additional building block to ensure aesthetically predictable results and achieves ideal long-term treatment successes in conjunction with all the other outstanding properties of the implant. It preserves the mucous membranes and takes account of the biological principles in the case of all indications. And not least it ensures ideal prosthetic handling.

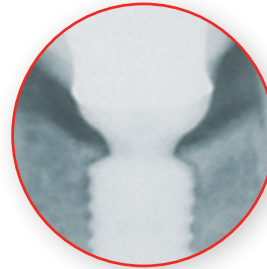

SURFACE

The high purity, sand-blasted and acid-etched surface extends the entire length of the implant to the implant shoulder. It possesses macro-micro roughness that is ideally dimensioned for the deposition of bone-forming cells and thus enhances the ideal and above all reliable long-term osseointegration of the MICROCONE.

It ensures well above average crestal bone formation in conjunction with the coronal microthread and the conical interface, throughout the implant shoulder to the interface.

- Implant diameter from D 3.0 mm to D 5.0 mm
- Implant lengths from L 6.5 mm to L 15.0 mm

5 implant diameters and 6 implant lengths facilitate ideal dimensioning of the implants for each indication.

The implant diameter 3 mm (two part) enables insertion in narrow tooth gaps of the upper side and lower side and middle incisors.

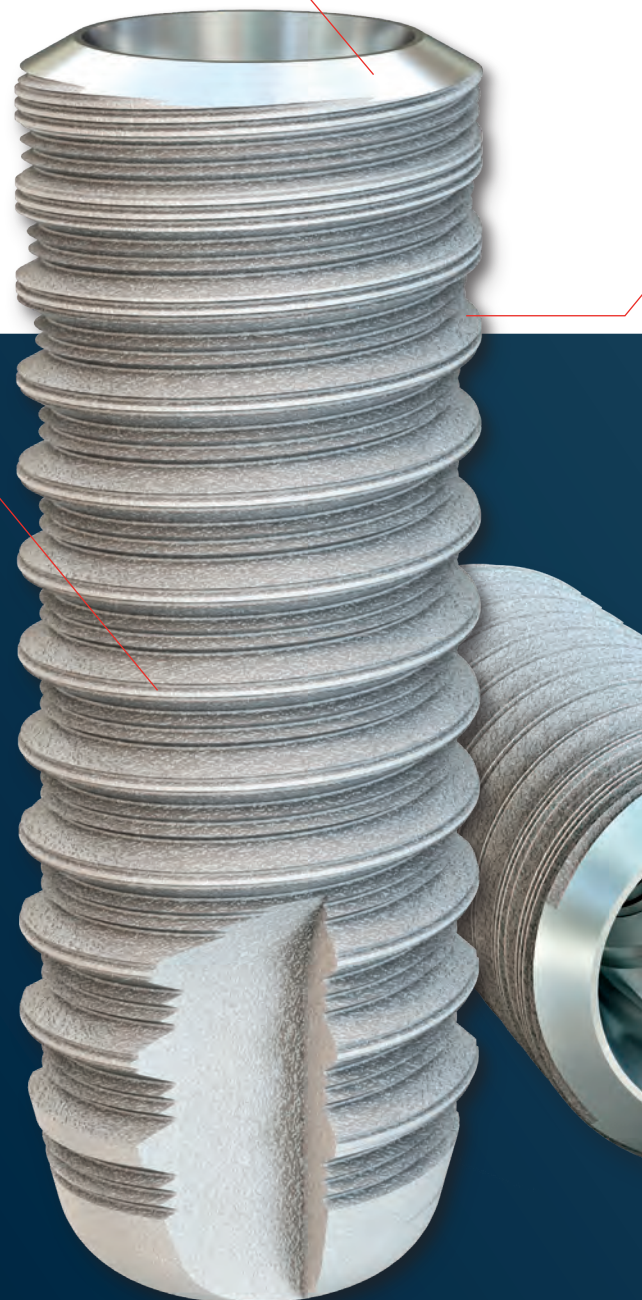
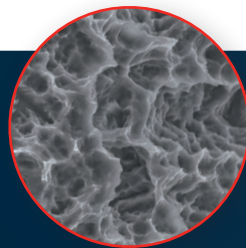

MICRO-MACRO THREAD

The unique, highly complex, self-cutting micro-macro thread of the implant promotes the permanent apposition of bone cells and their retention in a really ideal manner not just in the crestal area, but across the entire implant surface.

The continuous presence of the microthread on the macrothread sides and in the root of the thread generates the requirements for the largest possible contact surface with the bone.

In the case of subcrestal insertion this results in an accumulation of the bone over the shoulder to the interface in conjunction with the conical tight joint. Together with the biologically ideally dimensioned micro-thread, the conical

joint ensures that the bone also stays permanently in position. This for its part results in the supporting of the soft tissue above it and thus permanent red and white aesthetics. The thread, designed to be inserted atraumatically and the drilling protocol reduce the risk of pressure necrosis.

Short insertion time thanks to a thread pitch of 0.8 mm per turn (macro thread).

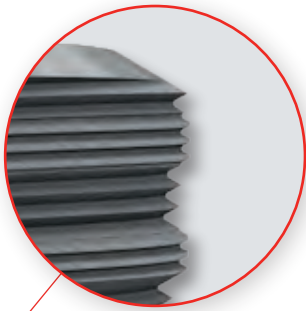

IMPLANT CONNECTION

The high precision friction-locked and keyed interface achieves the best possible levels of stability between the abutment and the implant.*

1. One conical connection between the implant and the abutment in the case of implants with a diameter of 3.5 to 5.0 mm.
2. Conical connection between the implant and the abutment that is free of micromovements. As a result of this no mechanical irritations arise and the retention of the peri-implant bone is positively influenced.
3. The connection is virtually bacteria and liquid proof and can reduce the risk of infection. It supports the development of healthy tissue that is not irritable and prevents bone depletion.
4. Integrated system-linked platform switching shifts the transition between the implant and the abutment from the implant shoulder to a central position. This keeps bacterial stimuli away from the peri-implant tissue in conjunction with the tight conical connection and creates a broad horizontal basis for the stable apposition of hard and soft tissue.
5. The implant abutment connection meets all the system requirements for permanent red-white aesthetics in conjunction with a subcrestal implant position and the coronal microthread section.

*Mechanically tested according to ISO 14801 by the Fraunhofer IWM in Freiburg (Germany).

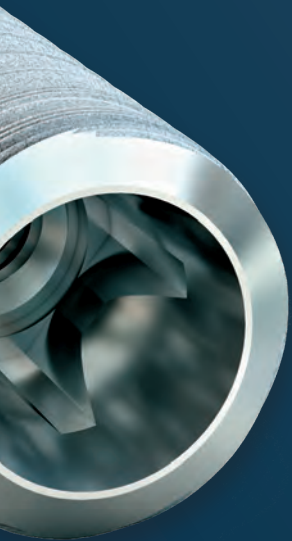

Color coding



The visible indication of the implant diameter, framed by the color coding, makes it easier to visually differentiate the respective implant diameters.

The drill parts for the implant bed preparation are also highlighted with these colors.



clear color coding of the implant diameters

Diameters and lengths

MICROCONE implants are available in five diameters and different lengths. Due to the needs-based size graduation they are suitable for all dental implantology indications for a minimized number of single implants.

	Length diameter	L6.5	L8.0	L9.0	L11.0	L13.0	L15.0
NI*	D 3.0				 1-01-06	 1-01-07	 1-01-08
	D 3.5		 2-01-30	 2-01-31	 2-01-32	 2-01-33	 2-01-34
RI*	D 4.0	 2-01-35	 2-01-36	 2-01-37	 2-01-38	 2-01-39	 2-01-40
	D 4.5	 2-01-41	 2-01-42	 2-01-43	 2-01-44	 2-01-45	 2-01-46
	D 4.5/3.5 conical	 2-01-53		 2-01-54	 2-01-55	 2-01-56	
	D 5.0	 2-01-47	 2-01-48	 2-01-49	 2-01-50	 2-01-51	 2-01-52

* Implant connection NI (Narrow Interface)

Implant connection RI (Regular Interface)

NI
D 3.0 MM

**MICROCONE IMPLANT
NI D 3.0 MM**

Please always note that the implant connection of the implant that has a diameter of 3.0 mm is dimensionally reduced and you can use it only to treat parts which are marked with the implant connection NI (Narrow Interface). Indications: Narrow gaps – only the upper jaw, lateral incisors and lower jaw lateral and central incisors area: 12, 22, 31, 32, 41, 42

RI

D 3.5 MM
- 5.0 MM

**MICROCONE IMPLANT
RI D 3.5-5.0 MM**

There is only one conical connection size between the implant and the abutment in the case of implants with a diameter of 3.5 to 5.0 mm, which is marked with RI (Regular Interface). This means that all the Implant pick-ups, gingiva formers and abutments fit into each of these implants. This markedly reduces the number of components required and thus achieves maximum transparency and efficiency.

Gingiva former

The following overview should make it easier for you to select the right gingiva former. The definitive selection of the gingival former must be performed in line with the patient's specific needs. The correct diameter of the emergence profile of the gingival former is based on the desired healing space and the implant position and thus decisively influences the correct ability to shape and the functionality of the prosthetics. You can use the gingival height gauge to determine the gingiva heights.

PLEASE NOTE:

Recommended torque to screw in the gingiva former: 5-10 Ncm (finger tight)

GINGIVA FORMER	Ø 6.5	Ø 6.5	Ø 4.5	Ø 4.5	Ø 5.5	Ø 3.5	Ø 5.5
IMPLANT POSITION	17 47	16 46	15 45	14 44	13 43	12 42	11 41
GINGIVA FORMER	Ø 6.5	Ø 6.5	Ø 4.5	Ø 4.5	Ø 5.5	Ø 3.5	Ø 3.5

Drill

The MICROCONE drills that are precisely matched with one another in terms of their geometry make it possible to tailor the diameter of the implant bearing to the bone quality.

Bone preparation should be adjusted to the individual bone quality with optimized drilling sequences. The exact and atraumatic preparation of the bony implant site should form a part of a successful implantation. The exact drilling sequence can be found in the „Drilling protocol“ at page 26.

MARKER DRILL

Used to punch mark the bone before the first deep drilling. Two variants are available. The first is the round drill (0-14-75) and the second is the needle drill (0-14-77). This can be used to guide the drilling process for instance, if the bone is tapered or for drilling in extraction sockets. The needle drill also features depth markings of 6 mm to 10 mm for depth measurement.

Round drill



Needle drill

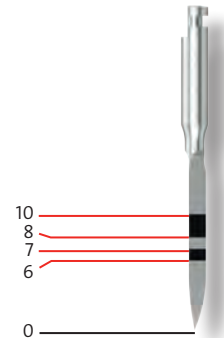

DRILL TYPES

Depending on the implant diameter and bone quality, up to five different drill types are available for the gentle preparation of the bony implant bed. The color coding makes choosing the right drill extremely easy.



THE PILOT DRILL

is marked with a white ring and is used as the first depth drill for any implant diameter.



THE STANDARD DRILL

is used for the final depth drilling of the corresponding implant diameter for D3/D4 bone quality. It is also used for incremental drilling for large implant diameters. Its implant diameter can be identified by its color ring.



THE CORTICAL DRILL

is used for the final depth drill for D1/D2 bone quality instead of the standard drill. Alongside the color coding for the implant diameter it also has a red ring.



THE REAMER

is used for the final depth drilling only for conical MICROCONE implants and D1/D2 bone quality. It can be identified by its conical form and features one yellow and one red color ring.

THREE DRILL LENGTHS

There are three drill lengths available for each implant diameter which can be differentiated based on the narrow, silver marking rings. The choice of drill length is only determined by the space available in the mouth. The depth marking on the cutting surfaces is identical for all three drill lengths. The drill lengths must, however, be taken into consideration when using and selecting the appropriate drill stops. Detailed information is available under „Drill stops“ at page 10.

Extra short drill

No narrow silver marking ring

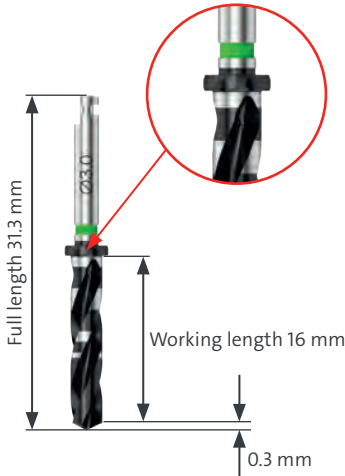

Short drill

1 narrow silver marking ring

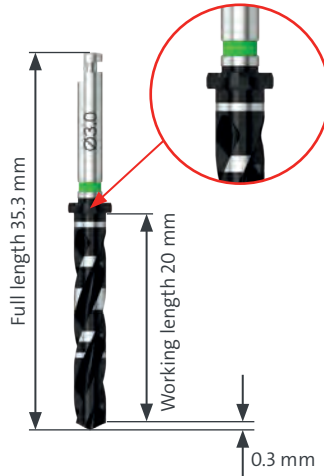

Long drill

2 narrow silver marking rings

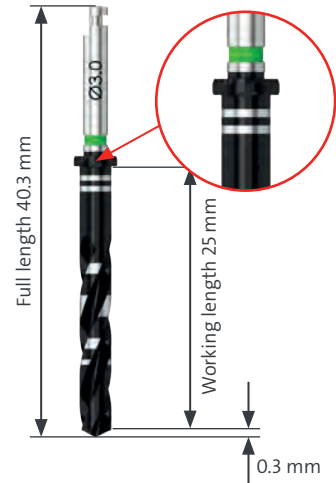

The MedentiGuide System supports all drill lengths.*
In the planning phase it is important to ensure that the correct drill length is selected.

DEPTH MARKING

The depth markings on the cutting edges of the drill are graduated according to the available MICROCONE implant lengths. The needle drill is only used to center-punch the bone surface and not for deep drilling. Please note that its depth markings are different.

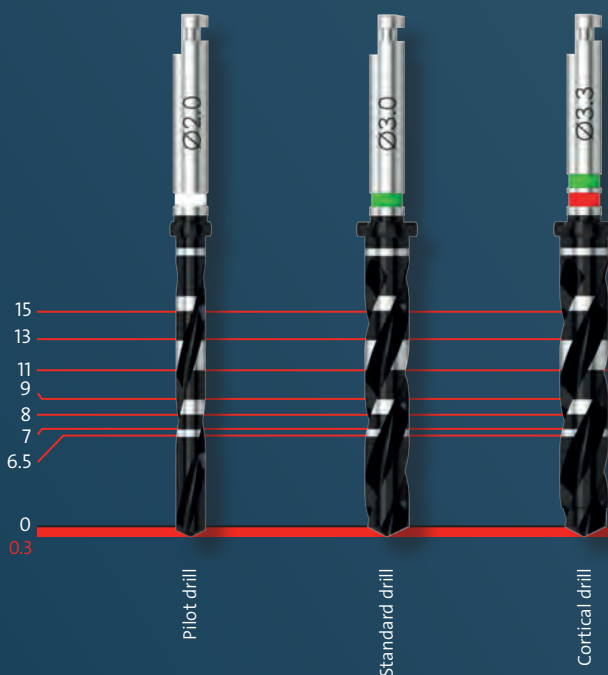

CAUTION

The stated drill depths do not include the 0.3 mm tip of the drill bit. Please observe their length if there is not much space available for anatomic structures. Please consult the table for the drill tip lengths.

Drill stops

The MICROCONE drill stop ensures precise control of the drilling depth during implant site preparation for placing MICROCONE implants. The advantage of the drill stop is its applicability both with simple and also more demanding cases in which the location of the mandibular nerve or sinus floor plays a role. The drill stops are supplied nonsterile and should be sterilised prior to use.





















IMPORTANT

MICROCONE drill stops are not indicated for:



















- Extraction alveoli, in which the bone cavity is much wider than the required support diameter for the drill stop.
- Use with a drilling template, because of the obstruction due to or with the template.

COMBINATION CHARTS DRILLS AND DRILL STOPS



















Extra short drills						
	Implant diameter/drill type	Implant length				
		L6.5	L8.0	L9.0	L11.0	
	All implant diameters Pilot drill Ø2.0 	68 1-14-33	67 1-14-32	2 1-14-08	1 1-14-07	
	D 3.0 Standard/Cortical  				12 1-14-18	
	D 3.5 Standard/Cortical  	70 2-14-72	69 2-14-71	24 2-14-18	23 2-14-17	
	D 4.0 Standard/Cortical  	72 2-14-74	71 2-14-73	35 2-14-29	34 2-14-28	
	D 4.5 Standard/Cortical  	74 2-14-76	73 2-14-75	46 2-14-40	45 2-14-39	
	D 4.5/3.5 (conical) Standard 	70 2-14-72		24 2-14-18	23 2-14-17	
	D 5.0 Standard/Cortical  	76 2-14-78	75 2-14-77	57 2-14-51	56 2-14-50	
		Drill stop number				

Use of the drill stop with the conical enlarging bit (Art. No. 2-14-61/2-14-62) is not possible due to application-related reasons.

Short drills

	Implant diameter/drill type	Implant length					
		L6.5	L8.0	L9.0	L11.0	L13.0	L15.0
	All implant diameters Pilot drill Ø2.0 	7 2-14-13	6 2-14-12	5 2-14-11	3 2-14-09	2 2-14-08	1 2-14-07
	D 3.0 Standard/Cortical  	/	/	/	14 1-14-20	13 1-14-19	12 1-14-18
	D 3.5 Standard/Cortical  	/	28 2-14-22	27 2-14-21	25 2-14-19	24 2-14-18	23 2-14-17
	D 4.0 Standard/Cortical  	40 2-14-34	39 2-14-33	38 2-14-32	36 2-14-30	35 2-14-29	34 2-14-28
	D 4.5 Standard/Cortical  	51 2-14-45	50 2-14-44	49 2-14-43	47 2-14-41	46 2-14-40	45 2-14-39
	D 4.5/3.5 (conical) Standard 	29 2-14-23	/	27 2-14-21	25 2-14-19	24 2-14-18	/
	D 5.0 Standard/Cortical  	62 2-14-56	61 2-14-55	60 2-14-54	58 2-14-52	57 2-14-51	56 2-14-50
Drill stop number							

Long drills

	Implant diameter/drill type	Implant length					
		L6.5	L8.0	L9.0	L11.0	L13.0	L15.0
	All implant diameters Pilot drill Ø2.0 	11 1-14-17	10 1-14-16	9 1-14-15	8 1-14-14	6 1-14-12	4 1-14-10
	D 3.0 Standard/Cortical  	/	/	/	19 1-14-25	17 1-14-23	15 1-14-21
	D 3.5 Standard/Cortical  	/	32 2-14-26	31 2-14-25	30 2-14-24	28 2-14-22	26 2-14-20
	D 4.0 Standard/Cortical  	44 2-14-38	43 2-14-37	42 2-14-36	41 2-14-35	39 2-14-33	37 2-14-31
	D 4.5 Standard/Cortical  	55 2-14-49	54 2-14-48	53 2-14-47	52 2-14-46	50 2-14-44	48 2-14-42
	D 4.5/3.5 (conical) Standard 	33 2-14-27	/	31 2-14-25	30 2-14-24	28 2-14-22	/
	D 5.0 Standard/Cortical  	66 2-14-60	65 2-14-59	64 2-14-58	63 2-14-57	61 2-14-55	59 2-14-53
Drill stop number							

MedentiGuide - The computer-aided treatment

MedentiGuide drill sleeves support the surgeon in preparing the implant bed for Medentika® implants.

Their use must be planned with a specially designed 3D planning system and surgical drilling template. You can plan the surgery with standard planning programs.

Treatment planning based on three dimensional imaging procedures (CT, DVT) enables high precision treatment planning and means that the treatment outcome can be accurately predicted.

An individual drilling template can be produced on the basis of the digital planning data. This ensures the exact and precise transfer of the planning outcome to the patient's mouth.

The advantages over conventional planning include:

- Precision three-dimensional planning and implantation, taking into account the desired restoration
- Automatic collision control that displays if the distances to the implants or nerves are too short
- Information on peri-implant bone quality so that conclusions can be drawn on the expected primary stability



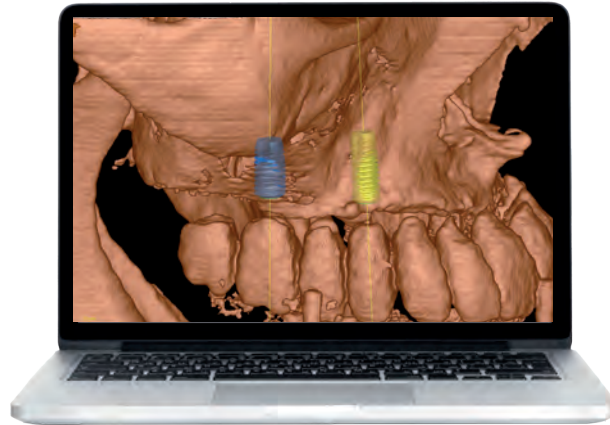

The following software manufacturers* currently support the MedentiGuide System:



* To some extent this depends on the availability of the updates of the specific manufacturer.

Note:

Medentika® GmbH accepts no liability for the correct planning, implementation and production of the drilling template. Sufficient knowledge of the 3D planning system being used and the Medentika® implant system is essential. It is imperative that the user is very confident in the use of 3D planning systems before using the MedentiGuide drill sleeves. Furthermore, sufficient expertise in preoperative implant planning and dental implantology is required.

Surgical tray

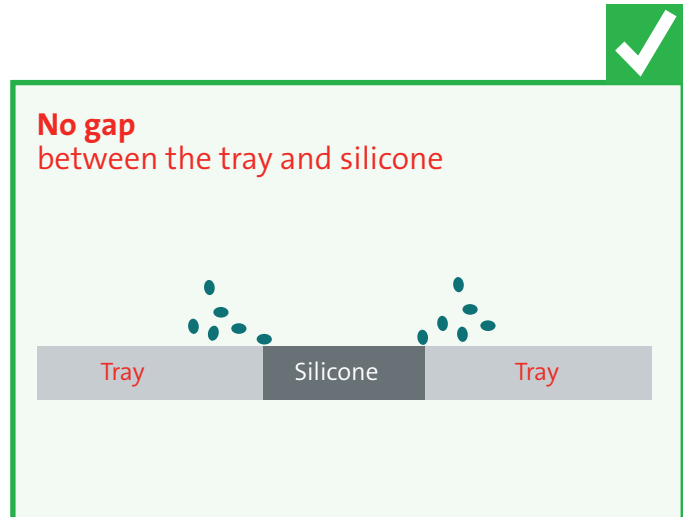

The benefits

- 1 Superior hygiene capability with intelligently designed silicon holders
- 2 Smooth, even surfaces accelerate and facilitate cleaning
- 3 Space for another drill set
- 4 10 additional slots
- 5 Removable metal dish for small parts



Surgical tray layout diagram

The surgical tray is available with four layout options:

- As tray without contents
- Prefilled with the most important extra short design instruments
- Prefilled with the most important short design instruments
- Prefilled with the most important long design instruments



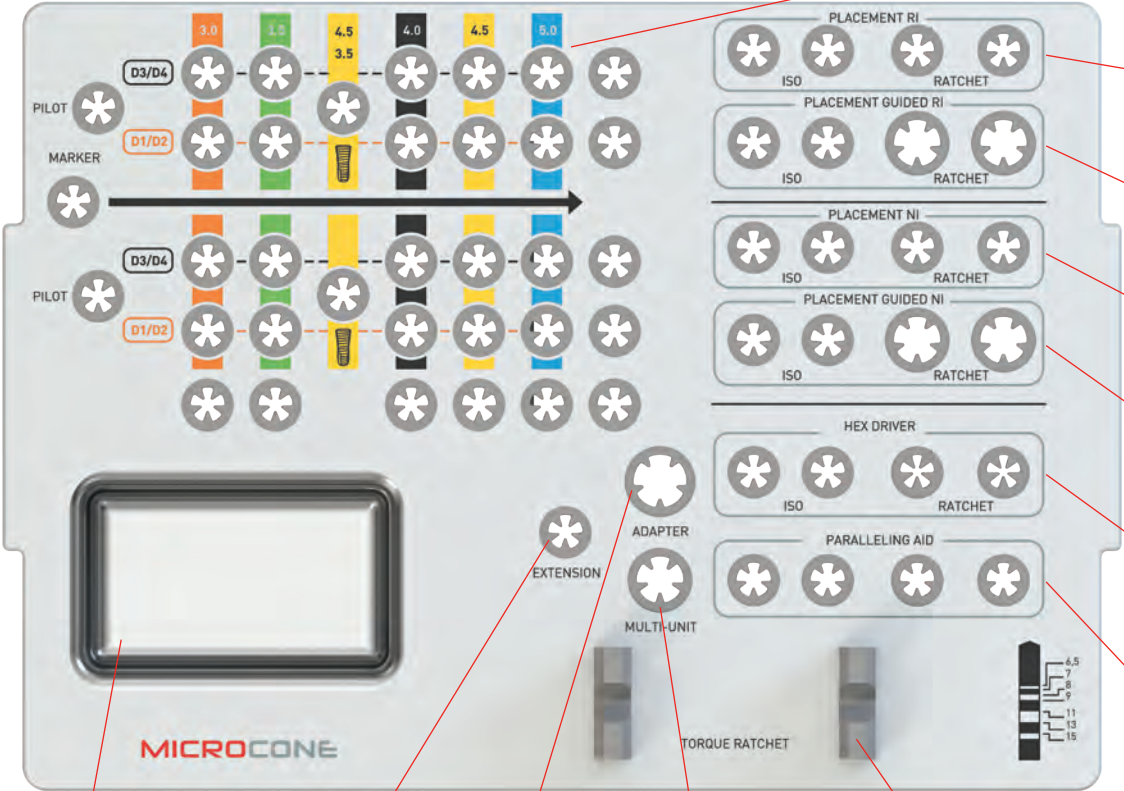



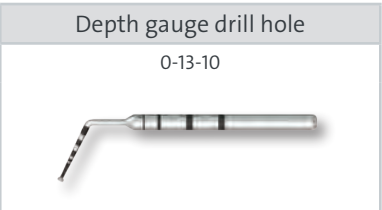







The exact layout of the surgical washing tray is shown in the item list of the corresponding variant. There is space for two drill sets and the associated placement instruments and free slots for additional instruments.





Removable stainless steel dish for small parts







Located in the floor of the surgery tray



Marker	Pilot	Bone quality	D3.0	D3.5	D4.5/3.5	D4.0	D4.5	D5.0
 0-14-77	 e-s: 1-14-29 s: 1-14-01 l: 1-14-04	D3/D4	 e-s: 1-14-30 s: 1-14-02 l: 1-14-05	 e-s: 2-14-63 s: 2-14-01 l: 2-14-09		 e-s: 2-14-65 s: 2-14-03 l: 2-14-11	 e-s: 2-14-67 s: 2-14-05 l: 2-14-13	 e-s: 2-14-69 s: 2-14-07 l: 2-14-15
		D1/D2	 e-s: 1-14-31 s: 1-14-03 l: 1-14-06	 e-s: 2-14-64 s: 2-14-02 l: 2-14-10	 s: 2-14-61 l: 2-14-62	 e-s: 2-14-66 s: 2-14-04 l: 2-14-12	 e-s: 2-14-68 s: 2-14-06 l: 2-14-14	 e-s: 2-14-70 s: 2-14-08 l: 2-14-16



e-s = extra-short; s = short; l = long



Placement instrument implant RI	
Contra-angle	Manual and ratchet
extra-short 2-13-32 short 2-13-33 long 2-13-34 	extra-short 2-13-35 short 2-13-36 long 2-13-37 

Placement instrument MedentiGuide RI	
Contra-angle	Manual and ratchet
extra-short 2-32-11 short: 2-32-07 long: 2-32-08 	extra-short 2-32-12 short: 2-32-09 long: 2-32-10 

Placement instrument implant NI	
Contra-angle	Manual and ratchet
1-13-12 	1-13-13 

Placement instrument MedentiGuide NI	
Contra-angle	Manual and ratchet
short: 1-32-07 long: 1-32-08 	short: 1-32-09 long: 1-32-10 

Placement instrument Hex 1.26	
Contra-angle	Manual and ratchet
extra-short 0-13-18 short 0-13-04 long 0-13-05 	short 0-13-22 long 0-13-23 

Paralleling aid		
Implant NI	Implant RI	Drill
1-13-11 	2-13-31 	0-13-16 

The surgery washing tray

THE EFFICIENT CLEANING METHOD.

The new surgery washing tray has been designed for the MICROCONE and QUATTROCONE instruments to be machine cleaned as easily and efficiently as possible.

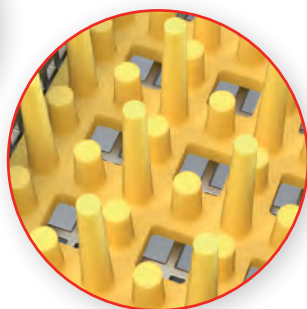
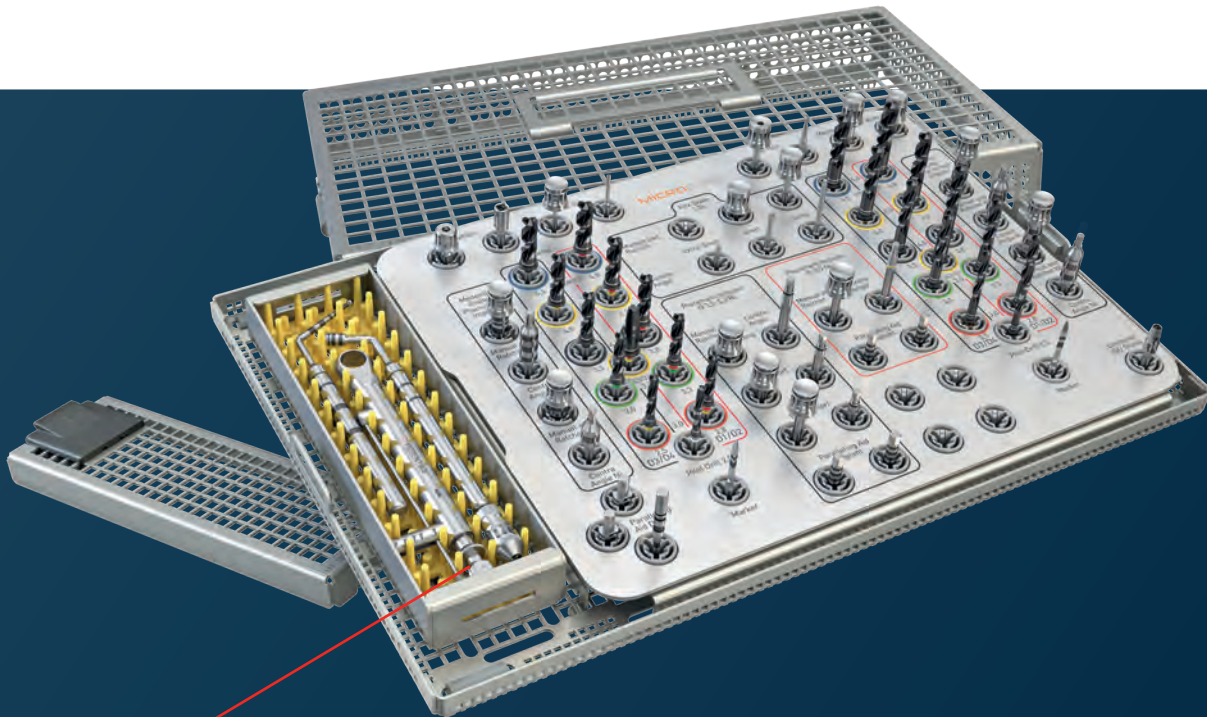

- The separate compartment with a silicone insert is used to store additional instruments, such as the torque ratchet surgical.
- The silicone insert prevents the instruments from touching, thereby preventing contact corrosion and ensuring thorough cleaning.
- The separate lid prevents small instruments from falling out.

If you prefer to use sterile containers, the JN295 from Aesculap®, for example, is a suitable option.



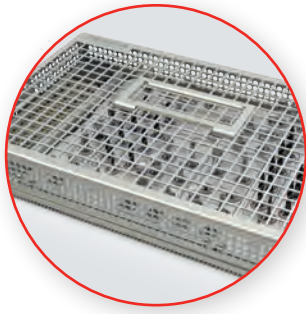

- The surgery washing tray is made of corrosion-free medical stainless steel.
- The height of the tray means that it easily holds even long drills and instruments.
- It can hold two full drill sets and the matching MedentiGuide placement instrument.



- The aluminum template printed with the layout diagram is used to clearly arrange all instruments.
- The template is removable to optimize the instrument cleaning process.

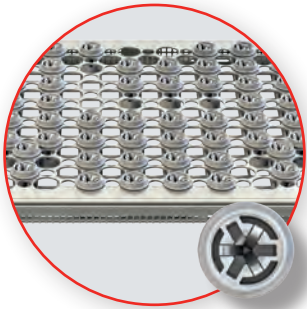

- The grid structure and the specially designed retaining sleeves with point-by-point instrument holder ensure that all instruments are well rinsed and thereby produces reproducible cleaning results.

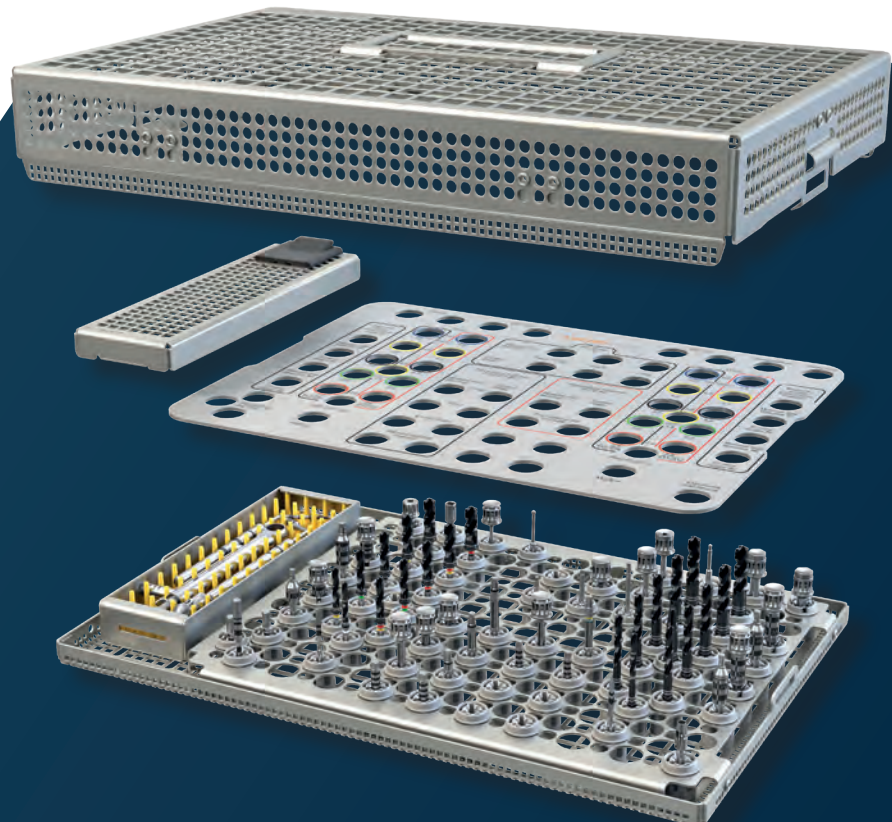

Surgery washing tray layout diagram

The surgery washing tray is available with four layout options:

- As tray without contents
- Prefilled with the most important extra short design instruments
- Prefilled with the most important short design instruments
- Prefilled with the most important long design instruments

The exact layout of the surgery washing tray is shown in the item list of the corresponding variant.

There is space for two drill sets and the associated placement instruments and free slots for additional instruments.

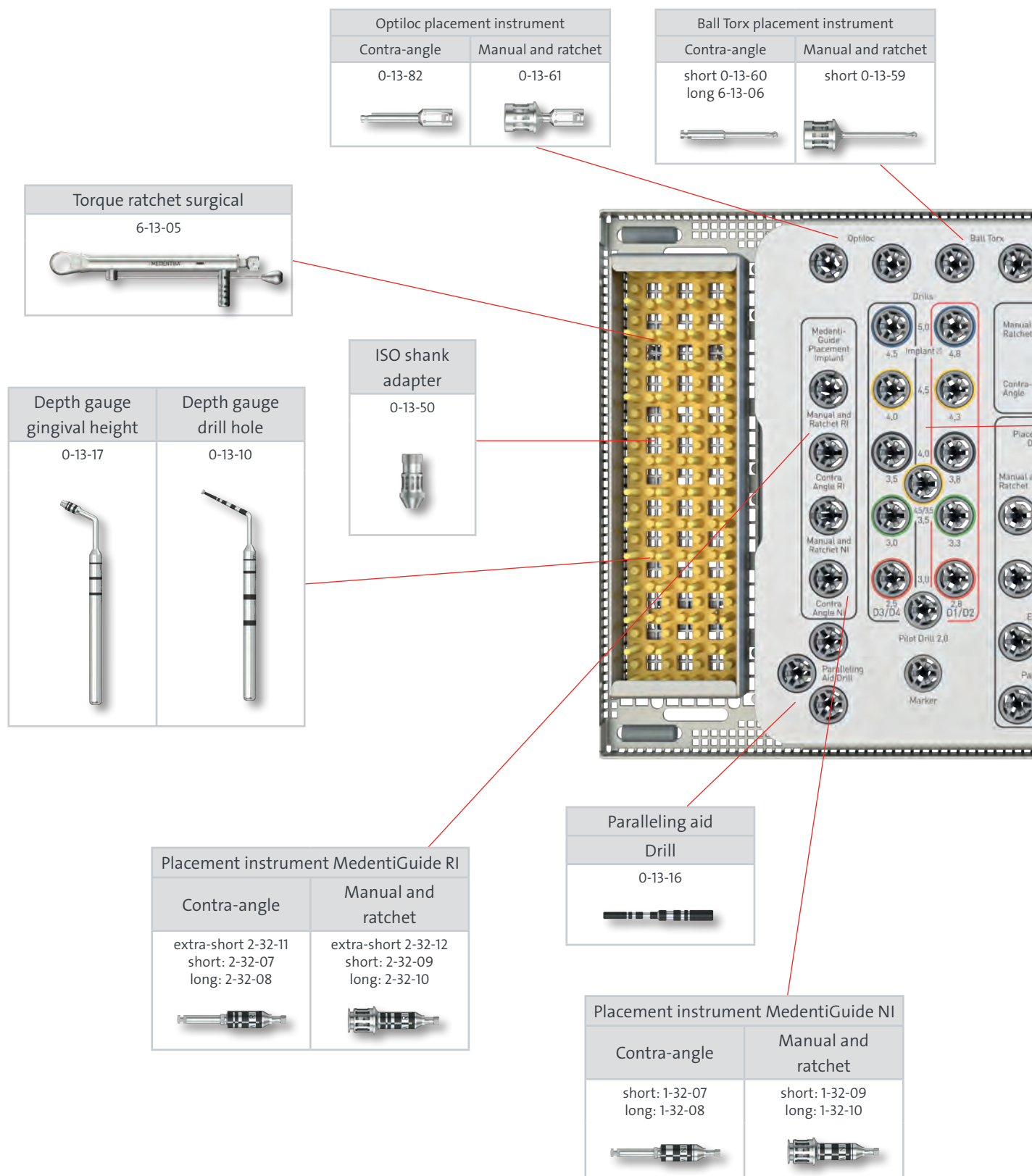

Placement instrument Hex 1.26	
Contra-angle	Manual and ratchet
extra-short 0-13-18 short 0-13-04 long 0-13-05	short 0-13-22 long 0-13-23

Ball Hex placement instrument	
Contra-angle	Manual and ratchet
0-13-39	0-13-38

Placement instrument MedentiBase
0-13-37

Multi-unit placement instrument
0-13-76

Extension ISO shank
0-13-55

Placement instrument implant NI		Paralleling aid Implant NI
Contra-angle	Manual and ratchet	Implant NI
1-13-12	1-13-13	1-13-11

Placement instrument implant RI		Paralleling aid Implant RI
Contra-angle	Manual and ratchet	Implant RI
extra-short 2-13-32 short 2-13-33 long 2-13-34	extra-short 2-13-35 short 2-13-36 long 2-13-37	2-13-31

D 3.0	D 3.5	D 4.0	D 4.5	D 4.5/3.5	D 5.0
-------	-------	-------	-------	-----------	-------

Color coding of the implant diameter

Implant diameter	Standard drill	Cortical drill
D5.0	e-s: 2-14-69 s: 2-14-07 l: 2-14-15	e-s: 2-14-70 s: 2-14-08 l: 2-14-16
D4.5	e-s: 2-14-67 s: 2-14-05 l: 2-14-13	e-s: 2-14-68 s: 2-14-06 l: 2-14-14
D4.0	e-s: 2-14-65 s: 2-14-03 l: 2-14-11	e-s: 2-14-66 s: 2-14-04 l: 2-14-12
D4.5/3.5	Reamer, conical s: 2-14-61 l: 2-14-62	
D3.5	e-s: 2-14-63 s: 2-14-01 l: 2-14-09	e-s: 2-14-64 s: 2-14-02 l: 2-14-10
D3.0	e-s: 1-14-30 s: 1-14-02 l: 1-14-05	e-s: 1-14-31 s: 1-14-03 l: 1-14-06
Pilot drill	e-s: 1-14-29 s: 1-14-01 l: 1-14-04	
Needle drill	0-14-77	

e-s = extra-short; s = short; l = long

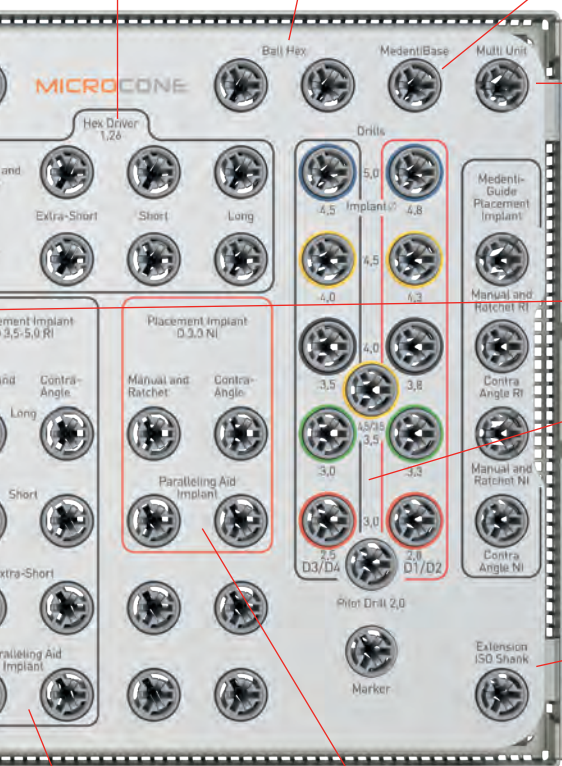

The new implant packaging

The new implant packaging for the MICROCONE system has been developed to make handling easier. The compact implant packaging makes storage more efficient. Important parameters, such as the article number, diameter, length, implant connection and type can be clearly identified.



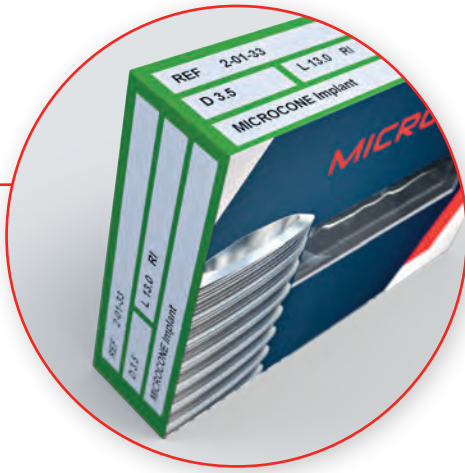

- Clear, compact information labels with the key data make it easier to distinguish between the implants. The implant diameters can be quickly and reliably identified at a glance by the color coding on the information labels.
- The double information label applied over the corner allows flexible implant storage; important product information is visible at a glance.



- Implants can be clearly identified through the inspection window.

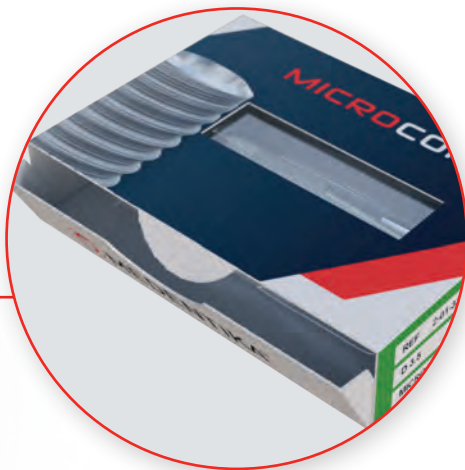

- The perforation on the outer packaging made of environmentally friendly cardboard makes it easy to access the sterile packaging.

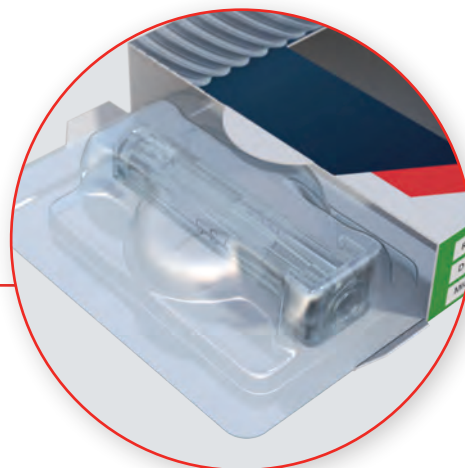

- The implant is supplied in a sterile container, protected by a blister with outer packaging. The blister thereby acts as a sterile barrier.

The new placement instrument

The new placement instrument is now even easier to use. Spring clips hold the implant on the placement instrument when the implant is removed.

Each is available in three lengths with an ISO shaft and is designed for manual use or use with a ratchet.

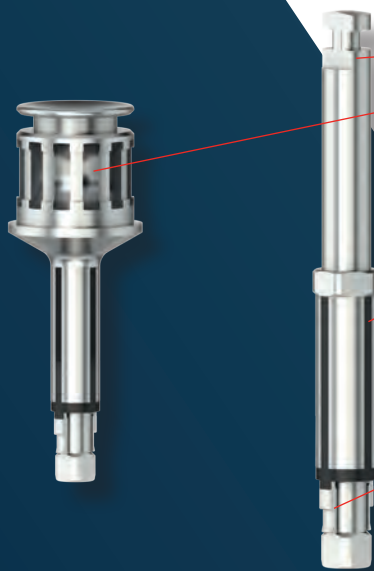

TWO VARIANTS

- With ISO shaft for use in the handpiece.
- With a knurled handle for manual operation and insertion in the torque ratchet surgical

POSITION MARKINGS

for precise alignment of the square implant connection.

SPRING CLIPS

for excellent implant purchase.

We recommend using the new placement instrument in combination with the MICROCONE implant.

Torque ratchet surgical

The three-part stainless steel torque ratchet has been especially designed for surgical use. It is easy to handle and can be sterilized assembled.

The torque scale is easy to read and extends from 0 to 45 Ncm.

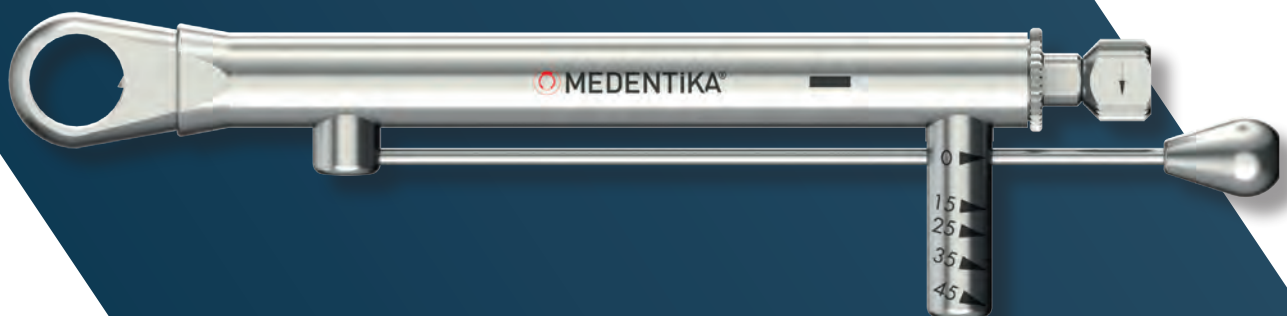

Implant removal



Take the blister out of the outer packaging.



Remove the Tyvek film from the blister pack to expose the container with the implant.
(Caution: This removes the sterile barrier.)



Hold the container upright and push the lid down.

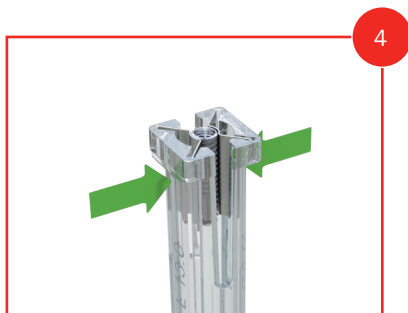

Secure the implant by slightly pressing on the sides of the container.



Turn the placement instrument clockwise slowly while inserting it into the implant until it slides into the square of the implant.

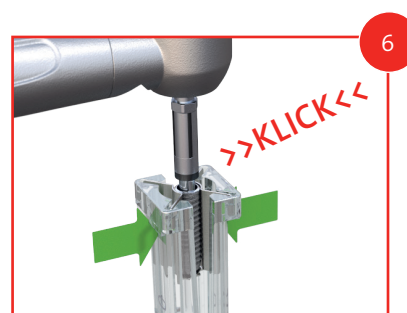

A "soft-click" signals that the implant is securely fixed in the placement instrument.
Please note:
No pressure needs to be applied!

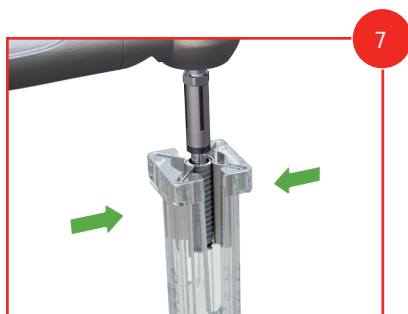

Before removing the implant, release the side pressure on the container.

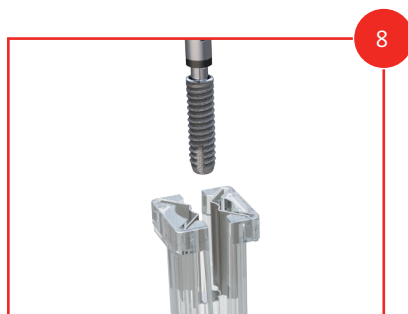

You can now safely remove the implant.



Insert the implant into the prepared implant bed.



The supplied closure screw is screwed into the underside of the container.























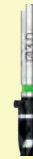



Use the HEX 1.26 placement instrument to remove the closure screw.



Turn the closure screw hand tight (5-10 Ncm) into the implant.

Drilling protocol

Marker with needle drill	Pilot drill	Implant diameter	Incremental drilling	Final drilling	Cortical drill for D1/D2 bone quality		
	2.0 mm*	 D 3.0		 2.5 mm*	 2.8 mm*		
		 D 3.5		 3.0 mm*	 3.3 mm*		
		 D 4.0	 3.0 mm*		 3.5 mm*	 3.8 mm*	
		 D 4.5	 3.0 mm*	 3.5 mm*	 4.0 mm*	 4.3 mm*	
		 D 5.0	 3.0 mm*	 3.5 mm*	 4.0 mm*	 4.5 mm*	 4.8 mm*
		 D 4.5/3.5			 3.0 mm*	 4.5 mm*	

*Drill diameter

The following applies for the final depth drilling:

If using the standard drill:

Drill diameter = implant diameter minus 0.5 mm (e.g.: MICROCONE D 3.5 mm = 3.0 mm final drill hole). Particularly suitable for use in average bone quality D3/D4.

If using the cortical drill:

Drill diameter = implant diameter minus 0.2 mm (e.g.: MICROCONE D 3.5 mm = 3.3 mm final drill). Especially suitable for average bone quality D1/D2 in the lower jaw. Here, if necessary, at full depth.

The recommended drill speed is 300-600 rpm. The maximum speed of 800 rpm should not be exceeded. Replace the drill bit after no more than 30 uses. Irrespective of this, the condition of the drill bit must be checked before and after each use to ensure it is in perfect condition and replaced where necessary.

Implant bed preparation

Example for MICROCONE D 4.5 x 11.0

Incision phase



The incision phase serves to form a mucosa flap to reveal the implantation point as bone. The incision phase is case-dependent and must be considered based on the patient's individual requirements depending on the healing mode (submerged or open healing).

First marker drill with the needle drill \varnothing 1.6 mm



The marking bore is inserted following the mobilization of the mucoperiosteal flap with the needle drill and can also alternatively be performed with the aid of a drilling template.

Pilot drill hole with the pilot drill \varnothing 2.0 mm



The pilot hole is drilled with the \varnothing 2.0 mm pilot drill. This defines the sagittal direction of the implant axis and the drilling depth (observe depth marking). A template-based implantation is recommended for the definitive alignment and to prevent deviations from the implant planning.

During the drilling, it is essential to ensure sufficient cooling, e.g. NaCl liquid, to avoid overheating and thus damage to the bone.

Reamer with the standard drill \varnothing 3.0 mm and \varnothing 3.5 mm



In this case, reaming is initially carried out with the standard drill bit \varnothing 3.0 mm and then with the standard drill bit \varnothing 3.5 mm. The laser markings that correspond to the respective implant length serve to inspect the depths for their part.

Subsequent reaming with the \varnothing 4.0 mm standard drill



The final enlargement drilling is completed using the standard drill bit \varnothing 4.0 mm.

Enlargement drilling with the cortical drill \varnothing 4.0/4.3 mm



It is recommended in the event of an extremely compact cortex and an average spongiosa or D1/D2 bone quality in the lower jaw, using additionally the cortical drill with 4.0/4.3 mm diameter.

Implant insertion

Implant placement with the contral angled handpiece



If the implant is inserted with the placement instrument for the angled handpiece, a max. number of 25 rpm and a torque of 35 Ncm should not be exceeded. However, if 35 Ncm is not sufficient to reach the final implant position, carefully unscrew the implant and enlarge the implant bed with the cortical drill (see implant bed preparation).

Final positioning with the torque ratchet surgical



If the implant is inserted with the torque ratchet surgical and the manual insertion instrument, the torque should not exceed 35 Ncm. If the torque is insufficient, we recommend carefully unscrewing the implant and then widening the implant bed with the cortical drill.

Remove the placement instrument



Once the implant has reached its final position, the placement instrument should be carefully removed from the implant (either with the handpiece or the ratchet).

Subcrestal implant position

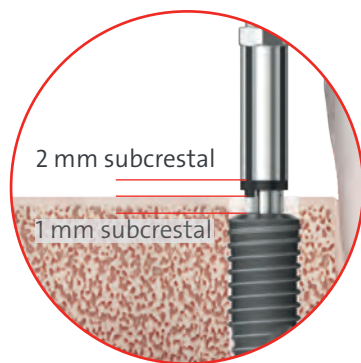
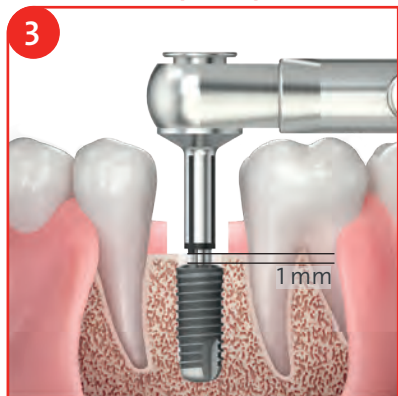

Due to the internal tapered connection the implant can be inserted approx. 1 mm subcrestally if there is a sufficient amount of bone in a vertical direction, in order to stabilise the periimplant bone better. Such a procedure ensures unencumbered healing even under the mucosa supported dentures and can improve the prosthetic results in aesthetically relevant area if there is not enough soft tissue available.

In the case of the pre-surgical planning and the observation of the laser marking of the bit you must ensure the subcrestal implant position has been planned in advance.

For depth control during subcrestal placement, laser markings are provided on the insertion instrument.

Paralleling aid



The paralleling aid can be used for orienting to the selected implant axis when inserting several implants.

This can be performed either by placing the paralleling aid in the implant bed or by placing the paralleling aid directly in the implant.

NOTE:

The plugged connection between the implant and the placement instrument means that it is not possible during an open sinus lift operation, for example, to pull the implant back if required, as this could release this connection.

In unfavorable cases there is a risk that an implant could be displaced in the maxillary sinus. Complex surgical measures would then have to be taken to recover the implant.

FURTHER TREATMENT

Option 1: Transgingival healing

Insertion of the gingiva former

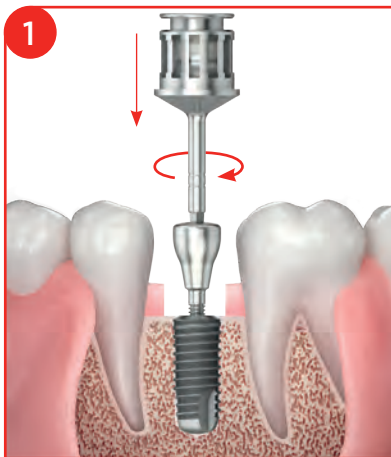

If the implant is intended for transgingival healing, the gingiva former must be inserted in accordance with the thickness of the soft tissue following the removal of the placement instrument.

The diameter of the gingiva former must be selected in accordance with the prosthetic requirements.

Wound closure



The wound edges adapted by sutures to the gingival tension free but saliva close by sutures.

PLEASE NOTE:

If the patient has a temporary restoration with a partial or full prosthesis, ensure that there is no contact with the gingiva former or the temporary restoration.

Option 2: Submerged healing

Inserting the closure screw

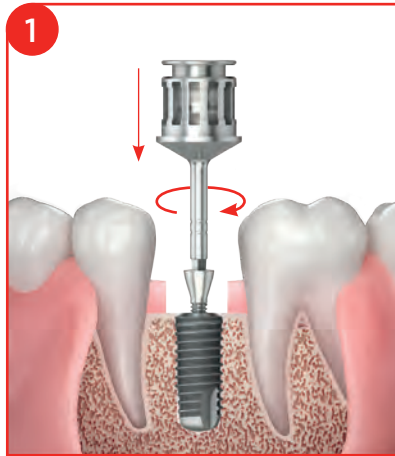

If the implant is intended for submerged healing, the closure screw must be inserted hand tight with the Hex 1.26 hand instrument following the removal of the placement instrument implant.

Wound closure

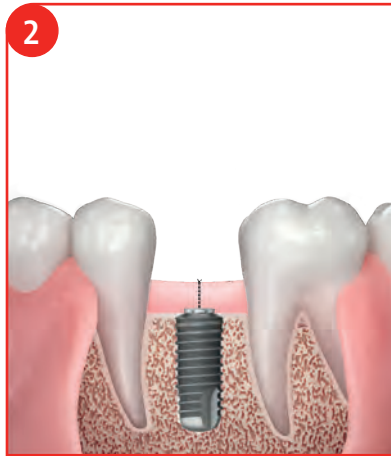

The alveolar ridge is closed by sutures to prevent ingress of saliva. The suturing should ideally be free of tension. To document the final implant position, a post operation X-ray could be done. A load-free healing phase must be ensured.

Incision



Following the localisation of the implant and the point-based anaesthetic directly above the implant a limited crestal cut is performed to the implant surface.

Uncovering



The central interior hex of the closure screw is found with the probe. Connective tissue or bone must be removed with the sharp curette above the locking closer screw. Bones which disrupt the emergence profile must be removed.

Removal of the closure screw

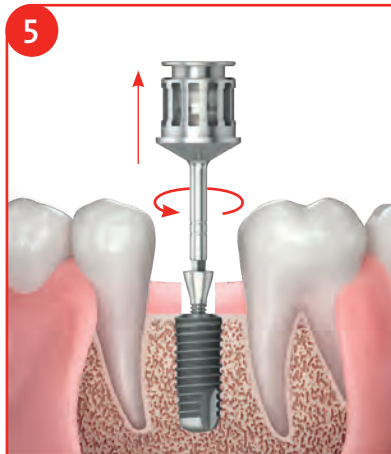

The closure screw must be removed with the Hex 1.26 hand instrument.

Insertion of the gingiva former

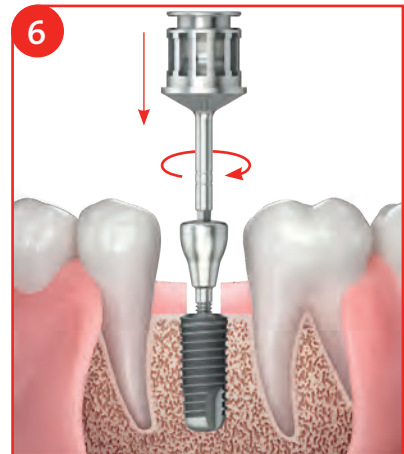

In accordance with the prosthetic requirements, the gingiva former that fits must be screwed in with the Hex 1.26 hand instrument. If necessary, adapt the wound margins to the gingiva former and secure with sutures.

Option 3: Immediate restoration with a provisional

If the clinical conditions allow an immediate restoration, the patient could get immediately after insertion of the implants an implant-supported denture by using the temporary abutment. It must be pointed out, that the temporary restoration has to stand out of occlusion so the implant can heal unloaded. The surgeon is responsible for explaining to the patient how load-free implant healing can be achieved postoperatively.



Preparing the temporary restoration

The temporary restoration is manufactured on the temporary abutment. The grinding operation should be performed outside of the mouth. Temporary abutments with an emergence diameter of 5.5 mm, straight and angled, are available to ensure easy individualization. Furthermore, provisional abutments are available as a metal base, which are used for additive procedures.



Insertion of the temporary restoration

Before inserting the temporary restoration, the interface of the implant should be cleaned with an air/water spray. The abutment is then inserted with a torque ratchet or a torque-controlled angled handpiece at 25 Ncm. For cemented restorations the use of provisional cementum is recommended. Remove all excess cement from the margin of the crown. Ensure that the wound is closed to prevent ingress of saliva.

PLEASE NOTE:

Temporary restorations must be replaced after six months at the latest.

Loads

The precondition for immediate stressing is primary stability that is greater than or equal to 35 Ncm. The possibility of excess stress through the temporary restoration should be ruled out. No occlusion or articulation contacts may be present. An insertion torque of at least 35 Ncm during the initial healing phase reduces the risk of macromovements at the implant bone boundary, for instance through tongue or cheek pressure.

Studies^{1,2} demonstrate that micromovements up to a threshold value of approx. 150 µm are tolerated during the osseointegration of dental implants.

Successful osseointegration can also take place in the event of “non-functional immediate stress” subject to the precondition that this value is not exceeded and all the other requirements are fulfilled.

¹ Brunski JB: Biomechanical factors affecting the bone-dental implant interface. Clin Mater 1992; 10 (3): 153–201

² Brunski JB: Avoid pitfalls overloading and micromotions of intraosseous implants. Dent Implantol Update 1993;4 (10): 77–81

PROSTHETIC CONCEPT

Continuity of the emergence profile

The shape (emergence profile) of the gingiva former and the temporary abutment exactly follows the shape of the prosthetic abutment. Optional individual implant pick-ups are available to better transfer the selected emergence profile to the model. These are also based exactly on the emergence profile of the gingiva former and abutment.

		MICROCONE			
		RI D 3.5 - 5.0			
		GINGIVA FORMER		TEMPORARY	
Gingiva former/ Provisonal					
	Ø 4.5 GH 1-6	Ø 5.5 GH 1-6	Ø 6.5 GH 1-6	Ø 5.5 GH 1-6	
Implant pick-up					
emergence profile for implant pick-up					
	Ø 4.5 GH 1-2	Ø 5.5 GH 1-2	Ø 6.5 GH 1-2	Ø 5.5 GH 1-2	
					
	Ø 4.5 GH 3-6	Ø 5.5 GH 3-6	Ø 6.5 GH 3-6	Ø 5.5 GH 3-6	
Abutment					
	Ø 4.5 GH 1.5-5	Ø 5.5 GH 1.5-5	Ø 6.5 GH 1.5-5	Ø 5.5 GH 1.5-5	



Medentika[®] **MICROCONE**

Product overview

MICROCONE implant

D 3.0 mm

- D 3.0
- Titanium Grade 5 CF
- Sterile packaged
- Incl. closure screw



Length	11 mm	13 mm	15 mm
Implant connection	NI	NI	NI
Article No.	1-01-06	1-01-07	1-01-08

MICROCONE implant

D 3.5 mm

- D 3.5
- Titanium Grade 4
- Sterile packaged
- Incl. closure screw



Length	8 mm	9 mm	11 mm	13 mm	15 mm
Implant connection	RI	RI	RI	RI	RI
Article No.	2-01-30	2-01-31	2-01-32	2-01-33	2-01-34

MICROCONE implant

D 4.0 mm

- D 4.0
- Titanium Grade 4
- Sterile packaged
- Incl. closure screw



Length	6,5 mm	8 mm	9 mm	11 mm	13 mm	15 mm
Implant connection	RI	RI	RI	RI	RI	RI
Article No.	2-01-35	2-01-36	2-01-37	2-01-38	2-01-39	2-01-40

MICROCONE implant

D 4.5 mm

- D 4.5
- Titanium Grade 4
- Sterile packaged
- Incl. closure screw



Length	6,5 mm	8 mm	9 mm	11 mm	13 mm	15 mm
Implant connection	RI	RI	RI	RI	RI	RI
Article No.	2-01-41	2-01-42	2-01-43	2-01-44	2-01-45	2-01-46

MICROCONE implant

D 4.5/3.5 mm

- conical
- D 4.5/3.5
- Titanium Grade 4
- Sterile packaged
- Incl. closure screw



Length	6,5 mm	9 mm	11 mm	13 mm
Implant connection	RI	RI	RI	RI
Article No.	2-01-53	2-01-54	2-01-55	2-01-56

MICROCONE implant

D 5.0 mm

- D 5.0
- Titanium Grade 4
- Sterile packaged
- Incl. closure screw



Length	6,5 mm	8 mm	9 mm	11 mm	13 mm	15 mm
Implant connection	RI	RI	RI	RI	RI	RI
Article No.	2-01-47	2-01-48	2-01-49	2-01-50	2-01-51	2-01-52

Closure screw

- Titanium Grade 5 CF
- Sterile packaged



Implant connection	NI	RI
Article No.	1-02-01	2-02-01

Closure screw bone ring technique

- Titanium Grade 5 CF



Implant connection	RI
Article No.	2-02-02

Placement instrument Bone ring screw

- Manual
- Stainless steel



Article No.	0-13-36
--------------------	---------

Gingiva former

- D 3.5
- Titanium Grade 5 CF
- Sterile packaged



Implant connection	NI	NI	NI
Gingiva height	2.0 mm	4.0 mm	6.0 mm
Diameter	D 3.5	D 3.5	D 3.5
Article No.	1-03-01	1-03-02	1-03-03

Gingiva former

- D 3.0
- Titanium Grade 5 CF
- Sterile packaged



Implant connection	RI
Gingiva height	4.0 mm
Diameter	D 3.0
Article No.	2-03-14

Gingiva former

- D 4.0
- Titanium Grade 5 CF
- Sterile packaged



Implant connection	RI	RI	RI
Gingiva height	3.0 mm	4.0 mm	6.0 mm
Diameter	D 4.0	D 4.0	D 4.0
Article No.	2-03-18	2-03-19	2-03-20

Gingiva former

- D 4.5
- Titanium Grade 5 CF
- Sterile packaged



Implant connection	RI	RI	RI	RI	RI
Gingiva height	1.0 mm	2.0 mm	3.0 mm	4.0 mm	6.0 mm
Diameter	D 4.5	D 4.5	D 4.5	D 4.5	D 4.5
Article No.	2-03-02	2-03-03	2-03-15	2-03-04	2-03-05

Gingiva former

- D 5.5
- Titanium Grade 5 CF
- Sterile packaged



Implant connection	RI	RI	RI	RI	RI
Gingiva height	1.0 mm	2.0 mm	3.0 mm	4.0 mm	6.0 mm
Diameter	D 5.5	D 5.5	D 5.5	D 5.5	D 5.5
Article No.	2-03-06	2-03-07	2-03-16	2-03-08	2-03-09

Gingiva former

- D 6.5
- Titanium Grade 5 CF
- Sterile packaged



Implant connection	RI	RI	RI	RI	RI
Gingiva height	1.0 mm	2.0 mm	3.0 mm	4.0 mm	6.0 mm
Diameter	D 6.5	D 6.5	D 6.5	D 6.5	D 6.5
Article No.	2-03-10	2-03-11	2-03-17	2-03-12	2-03-13

Surgery

Needle drill

- Stainless steel



Article No.

0-14-77

Round drill

- Stainless steel



Diameter

2.3 mm

Article No.

0-14-75

Drills for MICROCONE implant

- Stainless steel
- ADLC coated



Type	Pilot drill	Pilot drill	Pilot drill
Diameter	2.0 mm	2.0 mm	2.0 mm
Version	extra-short	short	long
Length	L 16 mm	L 20 mm	L 25 mm
Article No.	1-14-29	1-14-01	1-14-04

Drills for MICROCONE implant D 3.0

- Stainless steel
- ADLC coated



Type	Standard drill	Cortical drill	Standard drill	Cortical drill	Standard drill	Cortical drill
Diameter	2.5 mm	2.5/2.8 mm	2.5 mm	2.5/2.8 mm	2.5 mm	2.5/2.8 mm
Version	extra-short	extra-short	short	short	long	long
Length	16 mm	16 mm	20 mm	20 mm	25 mm	25 mm
Article No.	1-14-30	1-14-31	1-14-02	1-14-03	1-14-05	1-14-06

Drills for MICROCONE implant D 3.5

- Stainless steel
- ADLC coated



Type	Standard drill	Cortical drill	Standard drill	Cortical drill	Standard drill	Cortical drill
Diameter	3.0 mm	3.0/3.3 mm	3.0 mm	3.0/3.3 mm	3.0 mm	3.0/3.3 mm
Version	extra-short	extra-short	short	short	long	long
Length	16 mm	16 mm	20 mm	20 mm	25 mm	25 mm
Article No.	2-14-63	2-14-64	2-14-01	2-14-02	2-14-09	2-14-10

Drills for MICROCONE implant D 4.0

- Stainless steel
- ADLC coated



Type	Standard drill	Cortical drill	Standard drill	Cortical drill	Standard drill	Cortical drill
Diameter	3.5 mm	3.5/3.8 mm	3.5 mm	3.5/3.8 mm	3.5 mm	3.5/3.8 mm
Version	extra-short	extra-short	short	short	long	long
Length	16 mm	16 mm	20 mm	20 mm	25 mm	25 mm
Article No.	2-14-65	2-14-66	2-14-03	2-14-04	2-14-11	2-14-12

Drills for MICROCONE implant D 4.5

- Stainless steel
- ADLC coated



Type	Standard drill	Cortical drill	Standard drill	Cortical drill	Standard drill	Cortical drill
Diameter	4.0 mm	4.0/4.3 mm	4.0 mm	4.0/4.3 mm	4.0 mm	4.0/4.3 mm
Version	extra-short	extra-short	short	short	long	long
Length	16 mm	16 mm	20 mm	20 mm	25 mm	25 mm
Article No.	2-14-67	2-14-68	2-14-05	2-14-06	2-14-13	2-14-14

Drills for MICROCONE implant D 5.0

- Stainless steel
- ADLC coated



Type	Standard drill	Cortical drill	Standard drill	Cortical drill	Standard drill	Cortical drill
Diameter	4.5 mm	4.5/4.8 mm	4.5 mm	4.5/4.8 mm	4.5 mm	4.5/4.8 mm
Version	extra-short	extra-short	short	short	long	long
Length	16 mm	16 mm	20 mm	20 mm	25 mm	25 mm
Article No.	2-14-69	2-14-70	2-14-07	2-14-08	2-14-15	2-14-16

Drills for MICROCONE implant D 4.5/3.5

- Stainless steel
- ADLC coated



Type	Reamer, conical	Reamer, conical
Diameter (mm)	3.0/4.5	3.0/4.5
Version	short	long
Length	15 mm	20 mm
Article No.	2-14-61	2-14-62

Set extra-short drills

- Stainless steel



Type	Set			
Article No.	0-13-98			
Set consisting of:	1 pc.	1-14-29	Pilot drill	extra-short
	1 pc.	1-14-30	Standard drill	D 2.5 extra-short
	1 pc.	1-14-31	Cortical drill	D 2.5/2.8 extra-short
	1 pc.	2-14-63	Standard drill	D 3.0 extra-short
	1 pc.	2-14-64	Cortical drill	D 3.0/3.3 extra-short
	1 pc.	2-14-65	Standard drill	D 3.5 extra-short
	1 pc.	2-14-66	Cortical drill	D 3.5/3.8 extra-short
	1 pc.	2-14-67	Standard drill	D 4.0 extra-short
	1 pc.	2-14-68	Cortical drill	D 4.0/4.3 extra-short
	1 pc.	2-14-69	Standard drill	D 4.5 extra-short
	1 pc.	2-14-70	Cortical drill	D 4.5/4.8 extra-short

Set short drills

- Stainless steel



Type	Set			
Article No.	0-13-93			
Set consisting of:	1 pc.	1-14-01	Pilot drill	short
	1 pc.	1-14-02	Standard drill	D 2.5 short
	1 pc.	1-14-03	Cortical drill	D 2.5/2.8 short
	1 pc.	2-14-01	Standard drill	D 3.0 short
	1 pc.	2-14-02	Cortical drill	D 3.0/3.3 short
	1 pc.	2-14-03	Standard drill	D 3.5 short
	1 pc.	2-14-04	Cortical drill	D 3.5/3.8 short
	1 pc.	2-14-05	Standard drill	D 4.0 short
	1 pc.	2-14-06	Cortical drill	D 4.0/4.3 short
	1 pc.	2-14-07	Standard drill	D 4.5 short
	1 pc.	2-14-08	Cortical drill	D 4.5/4.8 short

Set long drills

• Stainless steel



Type	Set
Article No.	0-13-94

Type	Set
Article No.	0-13-94
Set consisting of:	
1 pc. 1-14-04	Pilot drill long
1 pc. 1-14-05	Standard drill D 2.5 long
1 pc. 1-14-06	Cortical drill D 2.5/2.8 long
1 pc. 2-14-09	Standard drill D 3.0 long
1 pc. 2-14-10	Cortical drill D 3.0/3.3 long
1 pc. 2-14-11	Standard drill D 3.5 long
1 pc. 2-14-12	Cortical drill D 3.5/3.8 long
1 pc. 2-14-13	Standard drill D 4.0 long
1 pc. 2-14-14	Cortical drill D 4.0/4.3 long
1 pc. 2-14-15	Standard drill D 4.5 long
1 pc. 2-14-16	Cortical drill D 4.5/4.8 long

MedentiGuide Outer sleeve standard

• Titanium Grade 5 CF



Diameter (mm)

D 6.3 /
d 5.01

Article No.

0-32-06

Please note: This sleeve is used for implants D 3.0 - D 4.5.

MedentiGuide Outer sleeve large

• Titanium Grade 5 CF



Diameter (mm)

D 8.3 /
d 7.01

Article No.

0-32-07

Please note: This sleeve is used for implants D 5.0.

MedentiGuide Adapter sleeve

• Titanium Grade 5 CF



Diameter (mm)

D 7.0 /
d 5.01

Article No.

0-32-08

Please note: This sleeve is used as a connecting piece between the Outer sleeve large and the Inner sleeves for the drill diameter D 2,0 - D 4,0.

MedentiGuide Inner sleeve MICROCONE implant

• Titanium Grade 4
• Pilot drill



Diameter (mm)

D 5.0 /
d 2.03

Colour code

white

Drill diameter

D 2.0 mm

Article No.

0-32-09

MedentiGuide Inner sleeve MICROCONE implant

- Titanium Grade 5 CF
- Standard drill



Diameter (mm)	D 5.0 / d 2.53	D 5.0 / d 3.03	D 5.0 / d 3.53	D 5.0 / d 4.03	D 7.0 / d 4.53
Colour code	orange	green	black	yellow	blue
Drill diameter	D 2.5 mm	D 3.0 mm	D 3.5 mm	D 4.0 mm	D 4.5 mm
Article No.	0-32-10	0-32-11	0-32-12	0-32-13	0-32-14

MedentiGuide Inner sleeve MICROCONE implant

- Titanium Grade 5 CF
- Cortical drill



Diameter (mm)	D 5.0 / d 2.83	D 5.0 / d 3.33	D 5.0 / d 3.83	D 5.0 / d 4.33	D 7.0 / d 4.83
Colour code	orange	green	black	yellow	blue
Drill diameter	D 2.8 mm	D 3.3 mm	D 3.8 mm	D 4.3 mm	D 4.8 mm
Article No.	0-32-22	0-32-23	0-32-24	0-32-25	0-32-26

Placement instrument MedentiGuide

- Stainless steel



Type	Outer sleeve standard	Outer sleeve large
Article No.	0-32-19	0-32-20

MedentiGuide Placement instrument Implant

- Manual and ratchet
- Hardened stainless steel

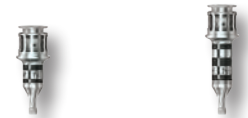

Implant connection	NI	NI
Type	MICROCONE	MICROCONE
Version	short	long
Article No.	1-32-09	1-32-10

Please note: These insertion tools are used to insert implants when using MedentiGuide sleeves.

MedentiGuide Placement instrument Implant

- Manual and ratchet
- Hardened stainless steel



Implant connection	RI	RI	RI
Type	MICROCONE	MICROCONE	MICROCONE
Version	extra-short	short	long
Article No.	2-32-12	2-32-09	2-32-10

Please note: These insertion tools are used to insert implants when using MedentiGuide sleeves.

MedentiGuide Placement instrument Implant

- Contra-angle
- Hardened stainless steel



Implant connection	NI	NI
Type	MICROCONE	MICROCONE
Version	short	long
Article No.	1-32-07	1-32-08

Please note: These insertion tools are used to insert implants when using MedentiGuide sleeves.

MedentiGuide Placement instrument Implant

- Contra-angle
- Hardened stainless steel



Implant connection	RI	RI	RI
Type	MICROCONE	MICROCONE	MICROCONE
Version	extra-short	short	long
Article No.	2-32-11	2-32-07	2-32-08

Please note: These insertion tools are used to insert implants when using MedentiGuide sleeves.





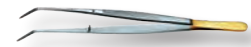













Tweezers

- diamond coated
- Stainless steel





















Article No.	22.014.03
--------------------	------------------



















Combination chart Drills and Drill stops

Extra short drills						
	Implant diameter/drill type	Implant length				
		L6.5	L8.0	L9.0	L11.0	
	All implant diameters Pilot drill Ø2.0 	68 1-14-33	67 1-14-32	2 1-14-08	1 1-14-07	
	D 3.0 Standard/Cortical  	/	/	/	12 1-14-18	
	D 3.5 Standard/Cortical  	70 2-14-72	69 2-14-71	24 2-14-18	23 2-14-17	
	D 4.0 Standard/Cortical  	72 2-14-74	71 2-14-73	35 2-14-29	34 2-14-28	
	D 4.5 Standard/Cortical  	74 2-14-76	73 2-14-75	46 2-14-40	45 2-14-39	
	D 4.5/3.5 (conical) Standard 	70 2-14-72	/	24 2-14-18	23 2-14-17	
	D 5.0 Standard/Cortical  	76 2-14-78	75 2-14-77	57 2-14-51	56 2-14-50	
Drill stop number						

Short drills

	Implant diameter/drill type	Implant length					
		L6.5	L8.0	L9.0	L11.0	L13.0	L15.0
	All implant diameters Pilot drill Ø2.0 	7 2-14-13	6 2-14-12	5 2-14-11	3 2-14-09	2 2-14-08	1 2-14-07
	D 3.0 Standard/Cortical  	/	/	/	14 1-14-20	13 1-14-19	12 1-14-18
	D 3.5 Standard/Cortical  	/	28 2-14-22	27 2-14-21	25 2-14-19	24 2-14-18	23 2-14-17
	D 4.0 Standard/Cortical  	40 2-14-34	39 2-14-33	38 2-14-32	36 2-14-30	35 2-14-29	34 2-14-28
	D 4.5 Standard/Cortical  	51 2-14-45	50 2-14-44	49 2-14-43	47 2-14-41	46 2-14-40	45 2-14-39
	D 4.5/3.5 (conical) Standard 	29 2-14-23	/	27 2-14-21	25 2-14-19	24 2-14-18	/
	D 5.0 Standard/Cortical  	62 2-14-56	61 2-14-55	60 2-14-54	58 2-14-52	57 2-14-51	56 2-14-50
Drill stop number							

Long drills

	Implant diameter/drill type	Implant length					
		L6.5	L8.0	L9.0	L11.0	L13.0	L15.0
	All implant diameters Pilot drill Ø2.0 	11 1-14-17	10 1-14-16	9 1-14-15	8 1-14-14	6 1-14-12	4 1-14-10
	D 3.0 Standard/Cortical  	/	/	/	19 1-14-25	17 1-14-23	15 1-14-21
	D 3.5 Standard/Cortical  	/	32 2-14-26	31 2-14-25	30 2-14-24	28 2-14-22	26 2-14-20
	D 4.0 Standard/Cortical  	44 2-14-38	43 2-14-37	42 2-14-36	41 2-14-35	39 2-14-33	37 2-14-31
	D 4.5 Standard/Cortical  	55 2-14-49	54 2-14-48	53 2-14-47	52 2-14-46	50 2-14-44	48 2-14-42
	D 4.5/3.5 (conical) Standard 	33 2-14-27	/	31 2-14-25	30 2-14-24	28 2-14-22	/
	D 5.0 Standard/Cortical  	66 2-14-60	65 2-14-59	64 2-14-58	63 2-14-57	61 2-14-55	59 2-14-53
Drill stop number							

Drill stop Pilot drill

- Stainless steel
- Pilot drill D 2.0



Diameter	2.0 mm	2.0 mm	2.0 mm	2.0 mm	2.0 mm
Length	L 5	L 7	L 8	L 9	L 9.5
Depth stop No.	1	2	67	3	68
Colour code	white	white	white	white	white
Article No.	1-14-07	1-14-08	1-14-32	1-14-09	1-14-33

Drill stop Pilot drill

- Stainless steel
- Pilot drill D 2.0



Diameter	2.0 mm	2.0 mm	2.0 mm	2.0 mm	2.0 mm
Length	L 10	L 11	L 12	L 13.5	L 14
Depth stop No.	4	5	6	7	8
Colour code	white	white	white	white	white
Article No.	1-14-10	1-14-11	1-14-12	1-14-13	1-14-14

Drill stop Pilot drill

- Stainless steel
- Pilot drill D 2.0



Diameter	2.0 mm	2.0 mm	2.0 mm
Length	L 16	L 17	L 18.5
Depth stop No.	9	10	11
Colour code	white	white	white
Article No.	1-14-15	1-14-16	1-14-17

Drill stop Standard drill / Cortical drill

- Stainless steel
- Standard drill / Cortical drill
D 2.5/2.8



Diameter	2.5/2.8 mm	2.5/2.8 mm	2.5/2.8 mm	2.5/2.8 mm	2.5/2.8 mm
Length	L 5	L 7	L 9	L 10	L 12
Depth stop No.	12	13	14	15	17
Colour code	orange	orange	orange	orange	orange
Article No.	1-14-18	1-14-19	1-14-20	1-14-21	1-14-23

Drill stop Standard drill / Cortical drill

- Stainless steel
- Standard drill / Cortical drill
- D 2.5/2.8



Diameter	2.5/2.8 mm
Length	L 14
Depth stop No.	19
Colour code	orange
Article No.	1-14-25

Drill stop Standard drill / Cortical drill

- Stainless steel
- Standard drill / Cortical drill
- D 3.0/3.3



Diameter	3.0/3.3 mm	3.0/3.3 mm	3.0/3.3 mm	3.0/3.3 mm	3.0/3.3 mm
Length	L 5	L 7	L 8	L 9	L 9.5
Depth stop No.	23	24	69	25	70
Colour code	green	green	green	green	green
Article No.	2-14-17	2-14-18	2-14-71	2-14-19	2-14-72

Drill stop Standard drill / Cortical drill

- Stainless steel
- Standard drill / Cortical drill
- D 3.0/3.3



Diameter	3.0/3.3 mm	3.0/3.3 mm	3.0/3.3 mm	3.0/3.3 mm	3.0/3.3 mm
Length	L 10	L 11	L 12	L 13.5	L 14
Depth stop No.	26	27	28	29	30
Colour code	green	green	green	green	green
Article No.	2-14-20	2-14-21	2-14-22	2-14-23	2-14-24

Drill stop Standard drill / Cortical drill

- Stainless steel
- Standard drill / Cortical drill
- D 3.0/3.3



Diameter	3.0/3.3 mm	3.0/3.3 mm	3.0/3.3 mm
Length	L 16	L 17	L 18.5
Depth stop No.	31	32	33
Colour code	green	green	green
Article No.	2-14-25	2-14-26	2-14-27

Drill stop Standard drill / Cortical drill

- Stainless steel
- Standard drill / Cortical drill
- D 3.5/3.8



Diameter	3.5/3.8 mm	3.5/3.8 mm	3.5/3.8 mm	3.5/3.8 mm	3.5/3.8 mm
Length	L 5	L 7	L 8	L 9	L 9.5
Depth stop No.	34	35	71	36	72
Colour code	black	black	black	black	black
Article No.	2-14-28	2-14-29	2-14-73	2-14-30	2-14-74

Drill stop Standard drill / Cortical drill

- Stainless steel
- Standard drill / Cortical drill
- D 3.5/3.8



Diameter	3.5/3.8 mm	3.5/3.8 mm	3.5/3.8 mm	3.5/3.8 mm	3.5/3.8 mm
Length	L 10	L 11	L 12	L 13.5	L 14
Depth stop No.	37	38	39	40	41
Colour code	black	black	black	black	black
Article No.	2-14-31	2-14-32	2-14-33	2-14-34	2-14-35

Drill stop Standard drill / Cortical drill

- Stainless steel
- Standard drill / Cortical drill
- D 3.5/3.8



Diameter	3.5/3.8 mm	3.5/3.8 mm	3.5/3.8 mm
Length	L 16	L 17	L 18.5
Depth stop No.	42	43	44
Colour code	black	black	black
Article No.	2-14-36	2-14-37	2-14-38

Drill stop Standard drill / Cortical drill

- Stainless steel
- Standard drill / Cortical drill
- D 4.0/4.3



Diameter	4.0/4.3 mm	4.0/4.3 mm	4.0/4.3 mm	4.0/4.3 mm	4.0/4.3 mm
Length	L 5	L 7	L 8	L 9	L 9.5
Depth stop No.	45	46	73	47	74
Colour code	yellow	yellow	yellow	yellow	yellow
Article No.	2-14-39	2-14-40	2-14-75	2-14-41	2-14-76

Drill stop Standard drill / Cortical drill

- Stainless steel
- Standard drill / Cortical drill
- D 4.0/4.3



Diameter	4.0/4.3 mm	4.0/4.3 mm	4.0/4.3 mm	4.0/4.3 mm	4.0/4.3 mm
Length	L 10	L 11	L 12	L 13.5	L 14
Depth stop No.	48	49	50	51	52
Colour code	yellow	yellow	yellow	yellow	yellow
Article No.	2-14-42	2-14-43	2-14-44	2-14-45	2-14-46

Drill stop Standard drill / Cortical drill

- Stainless steel
- Standard drill / Cortical drill
- D 4.0/4.3



Diameter	4.0/4.3 mm	4.0/4.3 mm	4.0/4.3 mm
Length	L 16	L 17	L 18.5
Depth stop No.	53	54	55
Colour code	yellow	yellow	yellow
Article No.	2-14-47	2-14-48	2-14-49

Drill stop Standard drill / Cortical drill

- Stainless steel
- Standard drill / Cortical drill
- D 4.5/4.8



Diameter	4.5/4.8 mm	4.5/4.8 mm	4.5/4.8 mm	4.5/4.8 mm	4.5/4.8 mm
Length	L 5	L 7	L 8	L 9	L 9.5
Depth stop No.	56	57	75	58	76
Colour code	blue	blue	blue	blue	blue
Article No.	2-14-50	2-14-51	2-14-77	2-14-52	2-14-78

Drill stop Standard drill / Cortical drill

- Stainless steel
- Standard drill / Cortical drill
- D 4.5/4.8



Diameter	4.5/4.8 mm	4.5/4.8 mm	4.5/4.8 mm	4.5/4.8 mm	4.5/4.8 mm
Length	L 10	L 11	L 12	L 13.5	L 14
Depth stop No.	59	60	61	62	63
Colour code	blue	blue	blue	blue	blue
Article No.	2-14-53	2-14-54	2-14-55	2-14-56	2-14-57

Drill stop Standard drill / Cortical drill

- Stainless steel
- Standard drill / Cortical drill
- D 4.5/4.8



Diameter	4.5/4.8 mm	4.5/4.8 mm	4.5/4.8 mm
Length	L 16	L 17	L 18.5
Depth stop No.	64	65	66
Colour code	blue	blue	blue
Article No.	2-14-58	2-14-59	2-14-60

Tray Drill stop MICROCONE

- sterilisable



Version	extra-short	short	long
Article No.	0-13-119	0-13-120	0-13-121

Placement instrument Implant

- Manual and ratchet
- Hardened stainless steel



Implant connection	NI
Type	MICROCONE
Version	long
Article No.	1-13-13

Placement instrument Implant

- Manual and ratchet
- Hardened stainless steel



Implant connection	RI	RI	RI
Type	MICROCONE / QUATTROCONE	MICROCONE / QUATTROCONE	MICROCONE / QUATTROCONE
Version	extra-short	short	long
Article No.	2-13-35	2-13-36	2-13-37

Placement instrument Implant

- Contra-angle
- Hardened stainless steel



Implant connection	NI
Type	MICROCONE
Version	long
Article No.	1-13-12

Placement instrument Implant

- Contra-angle
- Hardened stainless steel



Implant connection	RI	RI	RI
Type	MICROCONE / QUATTROCONE	MICROCONE / QUATTROCONE	MICROCONE / QUATTROCONE
Version	extra-short	short	long
Article No.	2-13-32	2-13-33	2-13-34

Extension ISO shank

- Contra-angle
- Stainless steel



Article No.	0-13-55
-------------	---------

Paralleling aid

- Titanium Grade 5 CF



Type	short	long
Diameter (mm)	2.0/3.0	2.0/3.0
Version		with depth marking
Article No.	0-13-01	0-13-16

Paralleling aid Implant

- Titanium Grade 5 CF



Implant connection	NI	RI
Version	with depth marking	with depth marking
Article No.	1-13-11	2-13-31

Torque ratchet

- with infinitely variable torque setting
- 10-40 Ncm
- Hardened stainless steel



Article No.	0-13-28
-------------	---------

Torque ratchet surgical

- with service instrument
- Hardened stainless steel



Article No.	6-13-05
-------------	---------

Ratchet surgical

- Hardened stainless steel



Article No.

6-13-01

Torque control device

- Hardened stainless steel



Article No.

6-13-02

Service instrument

- Hardened stainless steel



Article No.

6-13-03

ISO shank adapter

- Ratchet 0-13-28
- Hardened stainless steel



Article No.

0-13-50

Depth gauge drill hole

- Titanium Grade 5 CF



Article No.

0-13-10

Depth gauge gingival height

- Titanium Grade 5 CF



Implant connection
Article No.

RI
0-13-17

Surgery

Surgical tray MICROCONE

NEW



Version
Article No.

without contents
0-13-111

Surgical tray MICROCONE

NEW

NEW

NEW



Version
Article No.

extra-short drills
0-13-112

short drills
0-13-113

long drills
0-13-114

Surgery washing tray MICROCONE

NEW

NEW



Version
Article No.

without contents
0-13-79

Insert
0-13-85

Surgery washing tray MICROCONE

NEW

NEW

NEW



Version
Article No.

extra-short drills
0-13-102

short drills
0-13-106

long drills
0-13-107

0-13-112 Surgical tray / extra short drill



Number	Description				Quantity
0-13-111	Surgical tray	without contents			1 pc.
6-13-05	Torque ratchet surgical	with service instrument			1 pc.
0-13-04	Placement instrument	Hex 1.26	Contra-angle	short	1 pc.
0-13-05	Placement instrument	Hex 1.26	Contra-angle	long	1 pc.
0-13-10	Depth gauge drill hole	MICROCONE			1 pc.
0-13-16	Paralleling aid	MICROCONE	with depth marking		1 pc.
0-13-22	Placement instrument	Hex 1.26	Manual and ratchet	short	1 pc.
0-13-23	Placement instrument	Hex 1.26	Manual and ratchet	long	1 pc.
0-13-55	Extension ISO shank		Contra-angle		1 pc.
0-14-77	Needle drill				1 pc.
1-13-11	Paralleling aid	Implant	with depth marking		1 pc.
1-13-12	Placement instrument	Implant	Contra-angle	long	1 pc.
1-13-13	Placement instrument	Implant	Manual and ratchet	long	1 pc.
1-14-29	Pilot drill	D 2.0	extra-short		1 pc.
1-14-30	Standard drill	D 2.5	extra-short		1 pc.
1-14-31	Cortical drill	MICROCONE implant	extra-short		1 pc.
2-13-31	Paralleling aid	Implant	with depth marking		1 pc.
2-13-32	Placement instrument	Implant	Contra-angle	extra-short	1 pc.
2-13-33	Placement instrument	Implant	Contra-angle	short	1 pc.
2-13-35	Placement instrument	Implant	Manual and ratchet	extra-short	1 pc.
2-13-36	Placement instrument	Implant	Manual and ratchet	short	1 pc.
2-14-63	Standard drill	D 3.0	extra-short		1 pc.
2-14-64	Cortical drill	D 3.0/3.3	extra-short		1 pc.
2-14-65	Standard drill	D 3.5	extra-short		1 pc.
2-14-66	Cortical drill	D 3.5/3.8	extra-short		1 pc.
2-14-67	Standard drill	D 4.0	extra-short		1 pc.
2-14-68	Cortical drill	D 4.0/4.3	extra-short		1 pc.
2-14-69	Standard drill	D 4.5	extra-short		1 pc.
2-14-70	Cortical drill	D 4.5/4.8	extra-short		1 pc.
2-14-61	Reamer, conical	MICROCONE implant			1 pc.

0-13-113 Surgical tray / short drill



Number	Description	Quantity
0-13-111	Surgical tray without contents	1 pc.
6-13-05	Torque ratchet surgical with service instrument	1 pc.
0-13-04	Placement instrument Hex 1.26 Contra-angle short	1 pc.
0-13-05	Placement instrument Hex 1.26 Contra-angle long	1 pc.
0-13-10	Depth gauge drill hole MICROCONE	1 pc.
0-13-16	Paralleling aid MICROCONE with depth marking	1 pc.
0-13-22	Placement instrument Hex 1.26 Manual and ratchet short	1 pc.
0-13-23	Placement instrument Hex 1.26 Manual and ratchet long	1 pc.
0-13-55	Extension ISO shank Contra-angle	1 pc.
0-14-77	Needle drill	1 pc.
1-13-11	Paralleling aid Implant with depth marking	1 pc.
1-13-12	Placement instrument Implant Contra-angle long	1 pc.
1-13-13	Placement instrument Implant Manual and ratchet long	1 pc.
1-14-01	Pilot drill D 2.0 short	1 pc.
1-14-02	Standard drill D 2.5 short	1 pc.
1-14-03	Cortical drill MICROCONE implant short	1 pc.
2-13-31	Paralleling aid Implant with depth marking	1 pc.
2-13-32	Placement instrument Implant Contra-angle extra-short	1 pc.
2-13-33	Placement instrument Implant Contra-angle short	1 pc.
2-13-35	Placement instrument Implant Manual and ratchet extra-short	1 pc.
2-13-36	Placement instrument Implant Manual and ratchet short	1 pc.
2-14-01	Standard drill D 3.0 short	1 pc.
2-14-02	Cortical drill D 3.0/3.3 short	1 pc.
2-14-03	Standard drill D 3.5 short	1 pc.
2-14-04	Cortical drill D 3.5/3.8 short	1 pc.
2-14-05	Standard drill D 4.0 short	1 pc.
2-14-06	Cortical drill D 4.0/4.3 short	1 pc.
2-14-07	Standard drill D 4.5 short	1 pc.
2-14-08	Cortical drill D 4.5/4.8 short	1 pc.
2-14-61	Reamer, conical MICROCONE implant	1 pc.

0-13-114 Surgical tray / long drill



Number	Description				Quantity
0-13-111	Surgical tray	without contents			1 pc.
6-13-05	Torque ratchet surgical	with service instrument			1 pc.
0-13-04	Placement instrument	Hex 1.26	Contra-angle	short	1 pc.
0-13-05	Placement instrument	Hex 1.26	Contra-angle	long	1 pc.
0-13-10	Depth gauge drill hole	MICROCONE			1 pc.
0-13-16	Paralleling aid	MICROCONE	with depth marking		1 pc.
0-13-22	Placement instrument	Hex 1.26	Manual and ratchet	short	1 pc.
0-13-23	Placement instrument	Hex 1.26	Manual and ratchet	long	1 pc.
0-13-55	Extension ISO shank		Contra-angle		1 pc.
0-14-77	Needle drill				1 pc.
1-13-11	Paralleling aid	Implant	with depth marking		1 pc.
1-13-12	Placement instrument	Implant	Contra-angle	long	1 pc.
1-13-13	Placement instrument	Implant	Manual and ratchet	long	1 pc.
1-14-04	Pilot drill	D 2.0	long		1 pc.
1-14-05	Standard drill	D 2.5	long		1 pc.
1-14-06	Cortical drill	MICROCONE implant	long		1 pc.
2-13-31	Paralleling aid	Implant	with depth marking		1 pc.
2-13-32	Placement instrument	Implant	Contra-angle	extra-short	1 pc.
2-13-33	Placement instrument	Implant	Contra-angle	short	1 pc.
2-13-35	Placement instrument	Implant	Manual and ratchet	extra-short	1 pc.
2-13-36	Placement instrument	Implant	Manual and ratchet	short	1 pc.
2-14-09	Standard drill	D 3.0	long		1 pc.
2-14-10	Cortical drill	D 3.0/3.3	long		1 pc.
2-14-11	Standard drill	D 3.5	long		1 pc.
2-14-12	Cortical drill	D 3.5/3.8	long		1 pc.
2-14-13	Standard drill	D 4.0	long		1 pc.
2-14-14	Cortical drill	D 4.0/4.3	long		1 pc.
2-14-15	Standard drill	D 4.5	long		1 pc.
2-14-16	Cortical drill	D 4.5/4.8	long		1 pc.
2-14-62	Reamer, conical	MICROCONE implant			1 pc.

0-13-112 Surgical washing tray / extra short drill



Number	Description			Quantity
0-13-79	Surgery washing tray without contents			1 pc.
0-13-04	Placement instrument	Hex 1.26	Contra-angle short	1 pc.
0-13-05	Placement instrument	Hex 1.26	Contra-angle long	1 pc.
0-13-55	Extension ISO shank Contra-angle			1 pc.
0-13-10	Depth gauge drill hole			1 pc.
0-13-22	Placement instrument	Hex 1.26	Manual and ratchet short	1 pc.
0-13-23	Placement instrument	Hex 1.26	Manual and ratchet long	1 pc.
6-13-05	Torque ratchet surgical with service instrument			1 pc.
2-13-33	Placement instrument	Implant	Contra-angle short	1 pc.
2-13-36	Placement instrument	Implant	Manual and ratchet short	1 pc.
2-13-32	Placement instrument	Implant	Contra-angle extra-short	1 pc.
2-13-35	Placement instrument	Implant	Manual and ratchet extra-short	1 pc.
1-13-12	Placement instrument	Implant	Contra-angle long	1 pc.
1-13-13	Placement instrument	Implant	Manual and ratchet long	1 pc.
0-14-77	Needle drill			1 pc.
1-14-29	Pilot drill	D 2.0	extra-short	1 pc.
1-14-30	Standard drill	D 2.5	extra-short	1 pc.
1-14-31	Cortical drill	MICROCONE implant	extra-short	1 pc.
2-14-63	Standard drill	D 3.0	extra-short	1 pc.
2-14-64	Cortical drill	MICROCONE implant	extra-short	1 pc.
2-14-65	Standard drill	D 3.5	extra-short	1 pc.
2-14-66	Cortical drill	MICROCONE implant	extra-short	1 pc.
2-14-67	Standard drill	D 4.0	extra-short	1 pc.
2-14-68	Cortical drill	MICROCONE implant	extra-short	1 pc.
2-14-69	Standard drill	D 4.5	extra-short	1 pc.
2-14-70	Cortical drill	MICROCONE implant	extra-short	1 pc.
2-13-31	Paralleling aid	Implant	with depth marking	1 pc.
1-13-11	Paralleling aid	Implant	with depth marking	1 pc.
0-13-16	Paralleling aid	MICROCONE	with depth marking	1 pc.
2-14-61	Reamer, conical	MICROCONE implant		1 pc.

0-13-106 Surgical washing tray / short drill



Number	Description	Quantity
0-13-79	Surgery washing tray without contents	1 pc.
0-13-04	Placement instrument Hex 1.26 Contra-angle short	1 pc.
0-13-05	Placement instrument Hex 1.26 Contra-angle long	1 pc.
0-13-55	Extension ISO shank Contra-angle	1 pc.
0-13-10	Depth gauge drill hole MICROCONE	1 pc.
0-13-22	Placement instrument Hex 1.26 Manual and ratchet short	1 pc.
0-13-23	Placement instrument Hex 1.26 Manual and ratchet long	1 pc.
6-13-05	Torque ratchet surgical with service instrument	1 pc.
2-13-33	Placement instrument Implant Contra-angle short	1 pc.
2-13-36	Placement instrument Implant Manual and ratchet short	1 pc.
2-13-32	Placement instrument Implant Contra-angle extra-short	1 pc.
2-13-35	Placement instrument Implant Manual and ratchet extra-short	1 pc.
1-13-12	Placement instrument Implant Contra-angle long	1 pc.
1-13-13	Placement instrument Implant Manual and ratchet long	1 pc.
0-14-77	Needle drill	1 pc.
1-14-01	Pilot drill D 2.0 short	1 pc.
1-14-02	Standard drill D 2.5 short	1 pc.
1-14-03	Cortical drill D 2.5/2.8 short	1 pc.
2-14-01	Standard drill D 3.0 short	1 pc.
2-14-02	Cortical drill D 3.0/3.3 short	1 pc.
2-14-03	Standard drill D 3.5 short	1 pc.
2-14-04	Cortical drill D 3.5/3.8 short	1 pc.
2-14-05	Standard drill D 4.0 short	1 pc.
2-14-06	Cortical drill D 4.0/4.3 short	1 pc.
2-14-07	Standard drill D 4.5 short	1 pc.
2-14-08	Cortical drill D 4.5/4.8 short	1 pc.
2-13-31	Paralleling aid Implant with depth marking	1 pc.
1-13-11	Paralleling aid Implant with depth marking	1 pc.
0-13-16	Paralleling aid MICROCONE with depth marking	1 pc.
2-14-61	Reamer, conical MICROCONE implant	1 pc.

0-13-107 Surgical washing tray / long drill

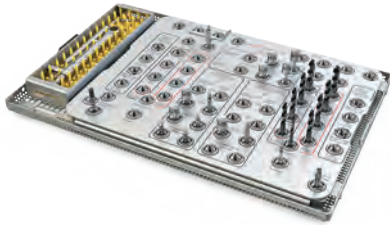

Number	Description			Quantity
0-13-79	Surgery washing tray	without contents		1 pc.
0-13-04	Placement instrument	Hex 1.26	Contra-angle short	1 pc.
0-13-05	Placement instrument	Hex 1.26	Contra-angle long	1 pc.
0-13-55	Extension ISO shank		Contra-angle	1 pc.
0-13-10	Depth gauge drill hole	MICROCONE		1 pc.
0-13-22	Placement instrument	Hex 1.26	Manual and ratchet short	1 pc.
0-13-23	Placement instrument	Hex 1.26	Manual and ratchet long	1 pc.
6-13-05	Torque ratchet surgical	with service instrument		1 pc.
1-13-12	Placement instrument	Implant	Contra-angle long	1 pc.
1-13-13	Placement instrument	Implant	Manual and ratchet long	1 pc.
0-14-77	Needle drill			1 pc.
1-14-04	Pilot drill	D 2.0	long	1 pc.
1-14-05	Standard drill	D 2.5	long	1 pc.
1-14-06	Cortical drill	MICROCONE implant	long	1 pc.
2-13-33	Placement instrument	Implant	Contra-angle short	1 pc.
2-13-36	Placement instrument	Implant	Manual and ratchet short	1 pc.
2-13-32	Placement instrument	Implant	Contra-angle extra-short	1 pc.
2-13-35	Placement instrument	Implant	Manual and ratchet extra-short	1 pc.
2-14-09	Standard drill	D 3.0	long	1 pc.
2-14-10	Cortical drill	D 3.0/3.3	long	1 pc.
2-14-11	Standard drill	D 3.5	long	1 pc.
2-14-12	Cortical drill	D 3.5/3.8	long	1 pc.
2-14-13	Standard drill	D 4.0	long	1 pc.
2-14-14	Cortical drill	D 4.0/4.3	long	1 pc.
2-14-15	Standard drill	D 4.5	long	1 pc.
2-14-16	Cortical drill	D 4.5/4.8	long	1 pc.
2-13-31	Paralleling aid	Implant	with depth marking	1 pc.
0-13-16	Paralleling aid	MICROCONE	with depth marking	1 pc.
1-13-11	Paralleling aid	Implant	with depth marking	1 pc.
2-14-62	Reamer, conical	MICROCONE implant		1 pc.

Implant pick-up Open tray

- incl. retention screw
- Titanium Grade 5 CF



Implant connection	NI	RI	RI
Version	long	short	long
Article No.	1-04-01	2-04-01	2-04-02

Implant pick-up Closed tray

- incl. abutment screw
- incl. Positioning cap
- Titanium Grade 5 CF



Implant connection	NI	RI
Article No.	1-04-08	2-04-17

Custom implant pick-up Open tray

- incl. retention screw
- Titanium Grade 5 CF



Implant connection	RI	RI
Version	short	long
Article No.	2-04-07	2-04-08

Custom implant pick-up Closed tray

- incl. abutment screw
- incl. Positioning cap
- Titanium Grade 5 CF

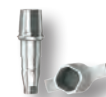

Implant connection	RI
Article No.	2-04-18

Emergence profile for implant pick-up customised

- Peek



	Ø4,5/1-2	Ø4,5/3-6	Ø5,5/1-2	Ø5,5/3-6	Ø6,5/1-2	Ø6,5/3-6
Diameter	4.5 mm	4.5 mm	5.5 mm	5.5 mm	6.5 mm	6.5 mm
Gingiva height	1-2 mm	3-6 mm	1-2 mm	3-6 mm	1-2 mm	3-6 mm
Article No.	2-04-09	2-04-12	2-04-10	2-04-13	2-04-11	2-04-14

Implant pick-up retention screw Open tray

• Titanium Grade 5 CF



Implant connection	NI	RI	RI
Type	long	short	long
Article No.	1-04-02	2-04-04	2-04-05

Positioning caps for implant pick-up Closed tray

• POM



Implant connection	RI
Article No.	2-04-19

Laboratory implant

• Titanium Grade 5 CF



Implant connection	NI	NI	RI	RI
Type		CADCAM		CADCAM
Placement instrument				2-05-03
Article No.	1-05-01	1-05-02	2-05-01	2-05-02

Placement instrument laboratory implant CAD/CAM

• Stainless steel



Implant connection	NI	RI
Article No.	1-05-03	2-05-03

Abutment screw

• Titanium Grade 5 CF



Placement instrument	Hex 1.26	Ball Torx	Ball Torx	Hex 1.26	Hex 1.26
Article No.	1-06-01	1-06-04	1-06-05	2-06-02	2-06-03

Please note: The correct choice of the abutment screw is stated with the respective abutment in the catalogue.

Abutment screw

- Titanium Grade 5 CF



Placement instrument

Ball Torx

Ball Torx

Ball Torx

Article No.

2-06-05

2-06-07

2-06-08

Please note:

The correct choice of the abutment screw is stated with the respective abutment in the catalogue.

Laboratory screw

- red coated



Article No.

1-06-02

2-06-04

Please note:

The correct choice of the laboratory screw is stated with the respective abutment in the catalogue.

Temporary abutment straight

- Titan/PVDF
- incl. abutment screw
- Recommended torque: 25 Ncm



Implant connection

RI

Gingiva height

3.5 mm

Diameter

5.5 mm

Abutment screw

2-06-03

Laboratory screw

2-06-04

Article No.

2-17-08

Temporary abutment angled

- Titan/PVDF
- incl. abutment screw
- Type 1 = angled over flat
- Type 2 = angled over corner
- Recommended torque: 25 Ncm

Type 1



Type 2



Implant connection

RI

Gingiva height

3.5 mm

Diameter

5.5 mm

Abutment screw

2-06-03

Laboratory screw

2-06-04

Article No. Type 1

2-17-09

Article No. Type 2

2-17-10

Prosthetics

Temporary abutment

- Titanium Grade 5 CF
- incl. abutment screw
- Recommended torque:
15 Ncm: NI
25 Ncm: RI



Implant connection	NI	RI
Placement instrument	Hex 1.26	Hex 1.26
Abutment screw	1-06-01	2-06-03
Laboratory screw	1-06-02	2-06-04
Article No.	1-17-04	2-17-07

Standard abutment straight

- Titanium Grade 5 CF
- incl. abutment screw
- Recommended torque: 15 Ncm



Implant connection	NI	NI	NI
Gingiva height	1.5 mm	3.0 mm	5.0 mm
Diameter	3.5 mm	3.5 mm	3.5 mm
Placement instrument	Hex 1.26	Hex 1.26	Hex 1.26
Abutment screw	1-06-01	1-06-01	1-06-01
Laboratory screw	1-06-02	1-06-02	1-06-02
Article No.	1-07-01	1-07-02	1-07-07

Standard abutment straight

- Titanium Grade 5 CF
- incl. abutment screw
- Recommended torque: 25 Ncm



Implant connection	RI
Gingiva height	0 mm
Diameter	3.5 mm
Placement instrument	Hex 1.26
Abutment screw	2-06-03
Laboratory screw	2-06-04
Article No.	2-07-20

Standard abutment straight

- Titanium Grade 5 CF
- incl. abutment screw
- Recommended torque: 25 Ncm



Implant connection	RI	RI	RI
Gingiva height	1.5 mm	1.5 mm	1.5 mm
Diameter	4.5 mm	5.5 mm	6.5 mm
Placement instrument	Hex 1.26	Hex 1.26	Hex 1.26
Abutment screw	2-06-03	2-06-03	2-06-03
Laboratory screw	2-06-04	2-06-04	2-06-04
Article No.	2-07-01	2-07-02	2-07-03

Standard abutment straight

- Titanium Grade 5 CF
- incl. abutment screw
- Recommended torque: 25 Ncm



Implant connection	RI	RI	RI
Gingiva height	3.0 mm	3.0 mm	3.0 mm
Diameter	4.5 mm	5.5 mm	6.5 mm
Placement instrument	Hex 1.26	Hex 1.26	Hex 1.26
Abutment screw	2-06-03	2-06-03	2-06-03
Laboratory screw	2-06-04	2-06-04	2-06-04
Article No.	2-07-04	2-07-05	2-07-06

Standard abutment straight

- Titanium Grade 5 CF
- incl. abutment screw
- Recommended torque: 25 Ncm



Implant connection	RI	RI	RI
Gingiva height	5.0 mm	5.0 mm	5.0 mm
Diameter	4.5 mm	5.5 mm	6.5 mm
Placement instrument	Hex 1.26	Hex 1.26	Hex 1.26
Abutment screw	2-06-03	2-06-03	2-06-03
Laboratory screw	2-06-04	2-06-04	2-06-04
Article No.	2-07-23	2-07-24	2-07-25

Standard abutment angled 18°

- Titanium Grade 5 CF
- incl. abutment screw
- Type 1 = angled over flat
- Type 2 = angled over corner
- Recommended torque: 15 Ncm



Implant connection	NI	NI	NI
Gingiva height	1.5 mm	3.0 mm	5.0 mm
Diameter	3.5 mm	3.5 mm	3.5 mm
Placement instrument	Hex 1.26	Hex 1.26	Hex 1.26
Abutment screw	1-06-01	1-06-01	1-06-01
Laboratory screw	1-06-02	1-06-02	1-06-02
Article No. Type 1	1-07-03	1-07-04	1-07-08
Article No. Type 2	1-07-05	1-07-06	1-07-09

Standard abutment angled 18°

- Titanium Grade 5 CF
- incl. abutment screw
- Type 1 = angled over flat
- Type 2 = angled over corner
- Recommended torque: 25 Ncm



	RI	RI	RI
Implant connection	RI	RI	RI
Gingiva height	1.5 mm	1.5 mm	1.5 mm
Diameter	4.5 mm	5.5 mm	6.5 mm
Placement instrument	Hex 1.26	Hex 1.26	Hex 1.26
Abutment screw	2-06-03	2-06-03	2-06-03
Laboratory screw	2-06-04	2-06-04	2-06-04
Article No. Type 1	2-07-07	2-07-08	2-07-09
Article No. Type 2	2-07-13	2-07-14	2-07-15

Standard abutment angled 18°

- Titanium Grade 5 CF
- incl. abutment screw
- Type 1 = angled over flat
- Type 2 = angled over corner
- Recommended torque: 25 Ncm



	RI	RI	RI
Implant connection	RI	RI	RI
Gingiva height	3.0 mm	3.0 mm	3.0 mm
Diameter	4.5 mm	5.5 mm	6.5 mm
Placement instrument	Hex 1.26	Hex 1.26	Hex 1.26
Abutment screw	2-06-03	2-06-03	2-06-03
Laboratory screw	2-06-04	2-06-04	2-06-04
Article No. Type 1	2-07-10	2-07-11	2-07-12
Article No. Type 2	2-07-16	2-07-17	2-07-18

Standard abutment angled 18°

- Titanium Grade 5 CF
- incl. abutment screw
- Type 1 = angled over flat
- Type 2 = angled over corner
- Recommended torque: 25 Ncm



	RI	RI	RI
Implant connection	RI	RI	RI
Gingiva height	5.0 mm	5.0 mm	5.0 mm
Diameter	4.5 mm	5.5 mm	6.5 mm
Placement instrument	Hex 1.26	Hex 1.26	Hex 1.26
Abutment screw	2-06-03	2-06-03	2-06-03
Laboratory screw	2-06-04	2-06-04	2-06-04
Article No. Type 1	2-07-26	2-07-27	2-07-28
Article No. Type 2	2-07-29	2-07-30	2-07-31

Castable gold abutment

- AU 60%; Pd 20%; Pt 19%; Ir 1%
- Cast-on
- incl. abutment screw
- Recommended torque:
15 Ncm: NI
25 Ncm: RI



Implant connection	NI	RI
Gold weight (g)	0,23	0,35
Placement instrument	Hex 1.26	Hex 1.26
Abutment screw	1-06-01	2-06-03
Laboratory screw	1-06-02	2-06-04
Article No.	1-08-01	2-08-01

Castable gold abutment rotating

- AU 60%; Pd 20%; Pt 19%; Ir 1%
- Cast-on
- incl. abutment screw
- Recommended torque: 25 Ncm



Implant connection	RI
Gold weight (g)	0,28
Placement instrument	Hex 1.26
Abutment screw	2-06-03
Laboratory screw	2-06-04
Article No.	2-08-02

Castable CoCr abutment

- CrCo alloy / CTE 14.1
- Cast-on
- incl. abutment screw
- Recommended torque:
15 Ncm: NI
25 Ncm: RI



Implant connection	NI	RI
Placement instrument	Hex 1.26	Hex 1.26
Abutment screw	1-06-01	2-06-03
Laboratory screw	1-06-02	2-06-04
Article No.	1-10-01	2-10-02

Please note: The Castable CoCr abutment may be cast on with NPM alloys where as the liquidus temperature does not exceed 1420°C.

Castable CoCr abutment rotating

- CrCo alloy / CTE 14.1
- Cast-on
- incl. abutment screw
- Recommended torque: 25 Ncm



Implant connection	RI
Placement instrument	Hex 1.26
Abutment screw	2-06-03
Laboratory screw	2-06-04
Article No.	2-10-03

Please note: The Castable CoCr abutment may be cast on with NPM alloys where as the liquidus temperature does not exceed 1420°C.

Prosthetics

Solid abutment straight

- Titanium Grade 5 CF
- incl. abutment screw
- Recommended torque: 25 Ncm



Implant connection	RI
Gingiva height	3.5 mm
Diameter	5.5 mm
Placement instrument	Hex 1.26
Abutment screw	2-06-03
Laboratory screw	2-06-04
Article No.	2-07-19

Please note: The Solid abutment will be delivered additional with Laboratory screw.

Solid abutment angled 18°

- Titanium Grade 5 CF
- incl. abutment screw
- Type 1 = angled over flat
- Type 2 = angled over corner
- Recommended torque: 25 Ncm



Implant connection	RI
Gingiva height	3.5 mm
Diameter	5.5 mm
Placement instrument	Hex 1.26
Abutment screw	2-06-03
Laboratory screw	2-06-04
Article No. Type 1	2-07-21
Article No. Type 2	2-07-22

Please note: The Solid abutment will be delivered additional with Laboratory screw.

Scanbody

- Titanium
- specially coated
- incl. retention screw



Implant connection	NI	RI
retention screw	1-06-03	2-06-06
Article No.	1-09-03	2-09-10

Please note: The Scanbody is sterilisable and for intra-oral scanning.

Titanium base ASC Flex

- angled screw channel
- Titanium Grade 5 CF
- incl. abutment screw
- Type SF = Screw channel angled over the flat of the scanbody Type
- Type SC = Screw channel angled over the right corner of the scanbody
- Recommended torque:
15 Ncm: NI
25 Ncm: RI

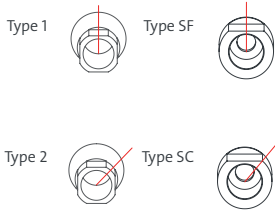

Implant connection	NI	NI	RI	RI
Chimney height	3.5-6.5	3.5-6.5	3.5-6.5	3.5-6.5
Gingiva height	1.2 mm	2.5 mm	1.2 mm	2.5 mm
Placement instrument	Ball Torx	Ball Torx	Kugel Torx	Kugel Torx
Abutment screw	1-06-04	1-06-05	2-06-07	2-06-08
Article No. Type 1	1-09-06	1-09-08	2-09-19	2-09-21
Article No. Type 2	1-09-07	1-09-09	2-09-20	2-09-22

Please note: To screw in the titanium base ASC Flex you need the Placement instrument Ball-Torx 0-13-60, 0-13-59 or 6-13-06. To select the desired direction of the angled screw channel, please consider the Instruction for use.

Modelling cap set

- burn-out plastic
- Scope of Delivery: four chimney heights

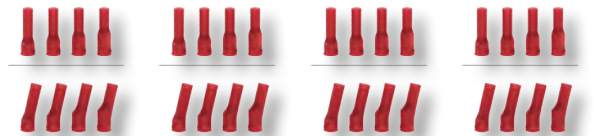

Modelling cap set straight	6-09-01	6-09-01	6-09-01	6-09-01
Modelling cap set angled	6-09-02	6-09-02	6-09-02	6-09-02

Titanium base ASC Flex rotating

- angled screw channel
- Titanium Grade 5 CF
- incl. abutment screw
- Recommended torque:
15 Ncm: NI
25 Ncm: RI



Implant connection	NI	RI
Chimney height	3.5-6.5	3.5-6.5
Gingiva height	1.2 mm	1.2 mm
Placement instrument	Ball Torx	Kugel Torx
Abutment screw	1-06-04	2-06-07
Article No.	1-09-10	2-09-23

Please note: To screw in the titanium base ASC Flex you need the Placement instrument Ball-Torx 0-13-60, 0-13-59 or 6-13-06. To select the desired direction of the angled screw channel, please consider the Instruction for use.

Modelling cap set

- burn-out plastic
- Scope of Delivery: four chimney heights

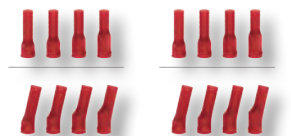

Modelling cap set straight	6-09-01	6-09-01
Modelling cap set angled	6-09-02	6-09-02

Prosthetics

Titanium base 2nd Generation

- Titanium Grade 5 CF
- incl. abutment screw
- Recommended torque: 15 Ncm



	NI	NI
Implant connection	NI	NI
Chimney height	3.5 mm	3.5 mm
Gingiva height	0.7 mm	1.2 mm
Placement instrument	Hex 1.26	Hex 1.26
Abutment screw	1-06-01	1-06-01
Laboratory screw	1-06-02	1-06-02
Article No.	1-09-01	1-09-02

Titanium base 2nd Generation

- Titanium Grade 5 CF
- incl. abutment screw
- Recommended torque: 25 Ncm

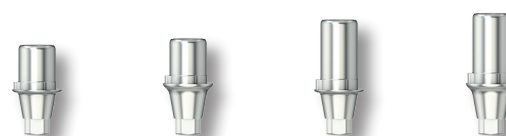

	RI	RI	RI	RI
Implant connection	RI	RI	RI	RI
Chimney height	3.5 mm	3.5 mm	5.5 mm	5.5 mm
Gingiva height	0.6 mm	1.1 mm	0.6 mm	1.1 mm
Placement instrument	Hex 1.26	Hex 1.26	Hex 1.26	Hex 1.26
Abutment screw	2-06-03	2-06-03	2-06-03	2-06-03
Laboratory screw	2-06-04	2-06-04	2-06-04	2-06-04
Article No.	2-09-11	2-09-13	2-09-12	2-09-14

Titanium base Bridges/ bars 2nd Generation

- rotating
- Titanium Grade 5 CF
- incl. abutment screw
- Recommended torque:
15 Ncm: NI
25 Ncm: RI



	NI	RI
Implant connection	NI	RI
Chimney height	3.5 mm	3.5 mm
Gingiva height	0.7 mm	0.6 mm
Placement instrument	Hex 1.26	Hex 1.26
Abutment screw	1-06-01	2-06-03
Laboratory screw	1-06-02	2-06-04
Article No.	1-09-04	2-09-15

Titanium base Cerec®

- Titanium Grade 5 CF
- incl. abutment screw
- Recommended torque: 25 Ncm

NEW



	RI	RI
Implant connection	RI	RI
Chimney height	4.7 mm	4.7 mm
Gingiva height	0.65 mm	2.0 mm
Placement instrument	Hex 1.26	Hex 1.26
Abutment screw	2-06-03	2-06-03
Laboratory screw	2-06-04	2-06-04
Article No.	2-09-17	2-09-24

ScanPost Cerec®

- Titanium Grade 5 CF
- incl. retention screw



Implant connection	RI
Abutment screw	2-06-03
Article No.	2-09-18

PreFace abutment Titanium Grade 5 CF

- incl. abutment screw
- Recommended torque:
15 Ncm: NI
25 Ncm: RI



Implant connection	NI	RI	RI
Diameter	11.5 mm	11.5 mm	16.0 mm
Placement instrument	Hex 1.26	Hex 1.26	Hex 1.26
Abutment screw	1-06-01	2-06-03	2-06-03
Laboratory screw	1-06-02	2-06-04	2-06-04
Article No.	1-90-02	2-90-02	2-90-03

PreFace abutment CrCo alloy / CTE 14.1

- incl. abutment screw
- Recommended torque:
15 Ncm: NI
25 Ncm: RI



Implant connection	NI	RI
Diameter	11.5 mm	16.0 mm
Placement instrument	Hex 1.26	Hex 1.26
Abutment screw	1-06-01	2-06-03
Laboratory screw	1-06-02	2-06-04
Article No.	1-90-03	2-90-06

TI-Forms-Abutment for Ceramill

- Titanium Grade 5 CF
- incl. abutment screw
- Recommended torque:
15 Ncm: NI
25 Ncm: RI



Implant connection	NI	RI
Diameter	11.5 mm	11.5 mm
Placement instrument	Hex 1.26	Hex 1.26
Abutment screw	1-06-01	2-06-03
Laboratory screw	1-06-02	2-06-04
Article No.	1-90-05-AG	2-90-07-AG

Please note: This is used with AmannGirrbach / Ceramill and Scanbody

TI-Forms-Abutment for M-Series

- Titanium Grade 5 CF
- incl. abutment screw
- Recommended torque:
15 Ncm: NI
25 Ncm: RI



Implant connection	NI	RI
Diameter	11.5 mm	11.5 mm
Placement instrument	Hex 1.26	Hex 1.26
Abutment screw	1-06-01	2-06-03
Laboratory screw	1-06-02	2-06-04
Article No.	1-90-05-ST	2-90-07-ST

Please note: This is used with Straumann/M-series.

MedentiBASE abutment straight

- Titanium Grade 5 CF
- Recommended torque: 25 Ncm



Implant connection	RI	RI	RI	RI	RI
Gingiva height	0.5 mm	1.5 mm	2.5 mm	3.5 mm	4.5 mm
Placement instrument	0-13-37	0-13-37	0-13-37	0-13-37	0-13-37
Article No.	2-28-01	2-28-02	2-28-03	2-28-04	2-28-05

MedentiBASE bridge screw

- Titanium Grade 5 CF
- Recommended torque: 15 Ncm

NEW



Placement instrument	Hex 1.26	Kugel Torx
Article No.	0-06-03	6-28-01

MedentiBASE prosthetic components

- incl. bridge screw
- Recommended torque: 15 Ncm
- titanium base / titanium cap:
incl. bridge screw
- Material: Titanium grade 5 KV
- Material scanbody: Titanium

NEW

NEW



Description	titanium base	titanium cap Flex	titanium base ASC
Placement instrument	Hex 1.26	Hex 1.26	Kugel Torx
Abutment screw	0-06-03	0-06-03	6-28-01
Article No.	0-28-05	0-28-22	6-28-02

MedentiBASE prosthetic components

- inkl. Brückenschraube
- Material Kunststoffkappe: Tecanat (PC)
- Material HSL-Kappe: AU 60%; Pd 20%; Pt 19%; Ir 1%

Description



gold cap, castable



plastic cap

Article No.

0-28-07

0-28-08

MedentiBASE prosthetic components for Passive-Fit

- inkl. Brückenschraube
- Empfohlenes Drehmoment: 15 Ncm
- Klebebasis Material: Titan Grade 5 KV
- Klebehülse inkl. Modellierschraube

Description



adhesive cap



adhesive casing



adhesive cap



adhesive casing

Version

Short

Short

Long

Long

Placement instrument

Hex 1.26

Hex 1.26

Abutment screw

0-06-03

0-06-03

Article No.

0-28-14

0-28-16

0-28-15

0-28-17

MedentiBASE scanbody

- Titanium specially coated
- incl. bridge screw



Article No.

0-28-13

Please note: The Scanbody is sterilisable and for intra-oral scanning.

MedentiBASE accessories

- Material Eindrehinstrument: Edelstahl
- Material Verschlusskappe: Titan Grade 5 KV
- Material Abformpfosten: Titan Grade 5 KV
- Material Laborimplantat: Titan Grade 5 KV
- Material Laborimplantat CAD/CAM: Edelstahl

Description



Placement instrument



cover cap



implant pick-up



Laboratory implant



Laboratory implant CAD-CAM

Placement instrument

Hex 1.26

Hex 1.26

0-13-37

Article No.

0-13-37

0-28-04

0-28-12

0-28-20

0-28-21

Multi-unit abutment straight

- Titanium Grade 5 CF
- Sterile packaged
- Recommended torque: 25 Ncm



RI



RI



RI



RI

Implant connection

Gingiva height

1.5 mm

2.5 mm

3.5 mm

5.5 mm

Placement instrument

0-13-76

0-13-76

0-13-76

0-13-76

Article No.

2-31-01

2-31-16

2-31-02

2-31-03

Prosthetics

Multi-unit abutment angled 17°

- Titanium Grade 5 CF
- Sterile packaged
- incl. abutment screw
- Type 1 = angled over flat
- Type 2 = angled over corner
- Recommended torque: 25 Ncm



Implant connection	RI	RI	RI
Gingiva height (mm)	1.1/2.5	2.1/3.5	4.1/5.5
Placement instrument	Hex 1.26	Hex 1.26	Hex 1.26
Abutment screw	2-06-02	2-06-02	2-06-02
Article No. Type 1	2-31-04	2-31-05	2-31-06
Article No. Type 2	2-31-10	2-31-11	2-31-12

Multi-unit abutment angled 30°

- Titanium Grade 5 CF
- Sterile packaged
- incl. abutment screw
- Type 1 = angled over flat
- Type 2 = angled over corner
- Recommended torque: 25 Ncm



Implant connection	RI	RI	RI
Gingiva height (mm)	0.6/3.0	1.6/4.0	3.1/5.5
Placement instrument	Hex 1.26	Hex 1.26	Hex 1.26
Abutment screw	2-06-02	2-06-02	2-06-02
Article No. Type 1	2-31-07	2-31-08	2-31-09
Article No. Type 2	2-31-13	2-31-14	2-31-15

Multi-unit bridge screw

- Material: Titan Grade 5 KV
- Recommended torque: 15 Ncm

NEW

Placement instrument	Hex 1.26	Kugel Torx
Article No.	0-31-02	6-31-01

Multi-unit prosthetic components

- Recommended torque: 15 Ncm
- titanium base / titanium cap: incl. bridge screw
- Material: Titanium grade 5 KV
- modelling sleeve: without Bridge screw
- Material: Tecanat (PC)

NEW

NEW

Description	titanium base	titanium base ASC	titanium cap Flex	modelling sleeve
Placement instrument	Hex 1.26	Kugel Torx	Hex 1.26	
Screw	0-31-02	6-31-01	0-31-02	
Article No.	0-31-09	6-31-02	0-31-20	0-31-11

Please note: The Multi-unit modelling sleeve can be used with the Multi-unit titanium base and Multi-unit titanium cap.

Multi-unit prosthetic components

- incl. bridge screw
- Recommended torque: 15 Ncm
- Material gold cap, castable:
"(AU 60%; Pd 20%; Pt 19%; Ir 1%)"
- Material CoCr cap:
CrCo alloy / CTE 14.1



Description	gold cap, castable	CoCr cap
Placement instrument	Hex 1.26	Hex 1.26
Screw	0-31-02	0-31-02
Article No.	0-31-07	0-31-08

Multi-unit screw patrix

- Material Novaloc:
Titan Grade 5 KV ADLC beschichtet
- Material MedentiLOC:
Titan Grade 5 KV TiN beschichtet
- Recommended torque: 15 Ncm

NEW

NEW



Description	Novaloc	MedentiLOC
Placement instrument	Hex 1.26	Hex 1.26
Article No.	0-31-18	0-31-19

Multi-unit scanbody

- Titanium specially coated
- incl. bridge screw



Version	straight	angled
Placement instrument	Hex 1.26	Hex 1.26
Screw	0-31-02	0-31-02
Article No.	0-31-01	0-31-16

Please note: The Scanbody is sterilisable and for intra-oral scanning.

Multi-unit Laboratory implant

- Titanium Grade 5 CF



Version	straight	angled	angled
Type		17°	30°
Article No.	0-31-05	0-31-12	0-31-13

Prosthetics

Multi-unit Laboratory implant CAD/CAM

- Titanium Grade 5 CF



Version	straight	angled	angled
Type		17°	30°
Placement instrument	0-13-76	0-13-17	0-13-17
Article No.	0-31-10	0-31-14	0-31-15

Multi-unit accessories

- 0-13-76 Placement instrument
- Multi-unit abutment
- 0-31-03 Multi-unit cover cap
- 0-31-04 Multi-unit implant pick-up
- 0-31-17 Placement instrument laboratory implant CAD/CAM



Article No.	0-13-76	0-31-03	0-31-04	0-31-17
-------------	----------------	----------------	----------------	----------------

MedentiLOC abutment straight

- Titanium Grade 5 CF
- TiN coated
- Recommended torque: 25 Ncm



Implant connection	RI	RI	RI	RI	RI
Gingiva height	1.5 mm	2.5 mm	3.5 mm	4.5 mm	5.5 mm
Placement instrument	Hex 1,26	Hex 1,26	Hex 1,26	Hex 1,26	Hex 1,26
Article No.	2-21-01	2-21-02	2-21-03	2-21-04	2-21-05

MedentiLOC abutment angled 15°

- Titanium Grade 5 CF
- TiN coated
- incl. abutment screw
- Type 1 = angled over flat
- Type 2 = angled over corner
- Recommended torque: 25 Ncm



Implant connection	RI	RI	RI	RI	RI
Gingiva height (mm)	1.0/2.0	2.0/3.0	3.0/4.0	4.0/5.0	5.0/6.0
Placement instrument	Kugel Hex	Kugel Hex	Kugel Hex	Kugel Hex	Kugel Hex
Abutment screw	2-06-02	2-06-02	2-06-02	2-06-02	2-06-02
Article No. Type 1	2-21-06	2-21-07	2-21-08	2-21-09	2-21-10
Article No. Type 2	2-21-11	2-21-12	2-21-13	2-21-14	2-21-15

Please note: To screw in the angled MedentiLOC abutments you need the special Placement instrument Ball-Hex 1.26 mm 0-13-39 or 0-13-38.

Novaloc® Processing package

- Matrix housing, titanium/PEEK
- Retention insert white
Retention force: light
- Retention insert yellow
Retention force: medium
- Retention insert green
Retention force: strong
- Mounting collar, silicone
- 2 pcs per package
- incl. mounting insert



Titanium



Peek

Material matrix housing	Titanium	Peek
Article No.	2010.601	2010.611
Please note:	The entire product overview is available in section Novaloc.	

Placement instrument MedentiLOC abutment, angled

- Stainless steel
- Ball Hex



Version	Manual and ratchet	Contra-angle
Article No.	0-13-38	0-13-39

MedentiLOC Laboratory implant

- Stainless steel



Version	straight	angled
Article No.	0-21-01	0-21-02

Novaloc abutment straight

- Titanium Grade 5 CF
- ADLC coated
- Recommended torque: 25 Ncm



Implant connection	RI	RI	RI	RI	RI
Gingiva height	1.0 mm	2.0 mm	3.0 mm	4.0 mm	5.0 mm
Placement instrument	Hex 1.26	Hex 1.26	Hex 1.26	Hex 1.26	Hex 1.26
Article No.	2-23-01	2-23-02	2-23-03	2-23-04	2-23-05

Novaloc abutment angled 15°

- Titanium Grade 5 CF
- ADLC coated
- incl. abutment screw
- Type 1 = angled over flat
- Type 2 = angled over corner
- Recommended torque: 25 Ncm



Implant connection	RI	RI	RI	RI	RI
Gingiva height (mm)	1.0/2.0	2.0/3.0	3.0/4.0	4.0/5.0	5.0/6.0
Placement instrument	Kugel Torx	Kugel Torx	Kugel Torx	Kugel Torx	Kugel Torx
Abutment screw	2-06-05	2-06-05	2-06-05	2-06-05	2-06-05
Article No. Type 1	2-23-06	2-23-07	2-23-08	2-23-09	2-23-10
Article No. Type 2	2-23-11	2-23-12	2-23-13	2-23-14	2-23-15

Please note: To screw in the angled Novaloc abutments you need the special Placement instrument Ball-Torx 0-13-60 or 0-13-59.

Prosthetics

Novaloc® Processing package

- Matrix housing, titanium/PEEK
- Retention insert white
Retention force: light
- Retention insert yellow
Retention force: medium
- Retention insert green
Retention force: strong
- Mounting collar, silicone
- 2 pcs per package
- incl. mounting insert



Titanium



PEEK

Material matrix housing

Article No. 2010.601

2010.611

Please note: The entire product overview is available in section Novaloc.

Placement instrument Ball Torx

- Hardened stainless steel

NEW



Version

Manual and ratchet

Contra-angle

Contra-angle

Type

L 30 mm

Article No.

0-13-59

0-13-60

6-13-06

Novaloc Laboratory implant

- Stainless steel



Version







straight

angled

Article No.

0-23-01

0-23-02

Picture	Part no.	Part description	Specifications	Amount per package
	2010.101	Novaloc Equipment Box	Incl. 3 tools Instrument brown 2010.741 Instrument blue 2010.731 Instrument grey 2010.751 (without load)	1 pc
	2010.601	Novaloc Processing package titanium	<ul style="list-style-type: none"> • Titanium matrix housing incl. mounting insert • Retention insert white • Retention insert yellow • Retention insert green • Mounting collar, silicone 	2 pcs
	2010.611	Novaloc Processing package PEEK	<ul style="list-style-type: none"> • PEEK matrix housing incl. mounting insert • Retention insert white • Retention insert yellow • Retention insert green • Mounting collar, silicone 	2 pcs
	2010.701	Novaloc Matrix housing, titanium (incl. mounting insert)	Matrix housing: titanium Mounting insert: POM	4 pcs
	2010.702	Novaloc Matrix housing, PEEK (incl. mounting insert)	Matrix housing: PEEK Mounting insert: POM	4 pcs
	special accessory 2010.703	Novaloc Matrix housing, titanium with attachment option (incl. mounting insert)	Matrix housing: titanium Mounting insert: POM	4 pcs
	special accessory 2010.710	Novaloc Retention insert red	PEEK Retention force: extra-light	4 pcs
	2010.711	Novaloc Retention insert white	PEEK Retention force: light	4 pcs
	2010.712	Novaloc Retention insert yellow	PEEK Retention force: medium	4 pcs
	2010.713	Novaloc Retention insert green	PEEK Retention force: strong	4 pcs
	2010.714	Novaloc Retention insert blue	PEEK Retention force: extra-strong	4 pcs
	special accessory 2010.715	Novaloc Retention insert black	PEEK Retention force: ultra-strong	4 pcs
	2010.721	Novaloc Model analogue	Aluminium	4 pcs
	2010.722	Novaloc Forming / fixing matrix	PEEK	4 pcs
	2010.723	Novaloc Processing spacer, white	POM	4 pcs
	2010.724	Novaloc Mounting collar, silicone	Silicone	10 pcs
	2010.725	Novaloc Mounting insert white	POM	4 pcs
	2010.731	Novaloc Demounting tool for mounting inserts + model analogue reposition aid (blue)	Aluminium, steel	1 pc
	2010.741	Novaloc Mounting and demounting tool for retention inserts (brown)	Aluminium, steel	1 pc
	2010.751	Novaloc Matrix housing extractor (grey)	Aluminium, steel	1 pc

Prosthetics

Optiloc abutment straight

- Titanium Grade 5 CF
- ADLC coated
- Recommended torque: 25 Ncm



Implant connection	RI	RI	RI	RI	RI
Gingiva height	1.0 mm	2.0 mm	3.0 mm	4.0 mm	5.0 mm
Placement instrument	0-13-61 0-13-82	0-13-61 0-13-82	0-13-61 0-13-82	0-13-61 0-13-82	0-13-61 0-13-82
Article No.	2-22-01	2-22-02	2-22-03	2-22-04	2-22-05

Optiloc® Processing package

- Matrix housing, titanium
- Retention insert white
Retention force: light
- Retention insert yellow
Retention force: medium
- Retention insert green
Retention force: strong
- Mounting collar, silicone
- 2 pcs per package

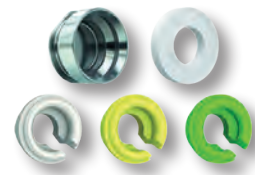

Material matrix housing	Titanium
Article No.	5202.0001
Please note: The entire product overview is available in section Optiloc.	

Placement instrument Optiloc abutment

- Stainless steel



Version	Manual and ratchet	Contra-angle
Article No.	0-13-61	0-13-82

Optiloc implant analogue

- Aluminium

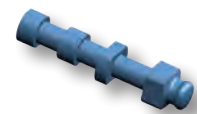

Version	4 piece
Article No.	2102.0024

Picture	Part no.	Part description	Specifications	Amount per package
	5102.0000	Optiloc Equipment Box	Incl. 3 tools Instrument brown 3202.0001 Instrument blue 3202.0002 Instrument grey 3202.0003 (without load)	1 pc
	5202.0001	Optiloc Processing package titanium	<ul style="list-style-type: none"> • Titanium matrix housing • Retention insert white • Retention insert yellow • Retention insert green • Mounting collar, silicone 	2 pcs
	2102.0001	Optiloc Matrix housing, titanium	Matrix housing: titanium	4 pcs
	2102.0009	Optiloc Matrix housing, elliptic	Titanium	4 pcs
	special accessory 2102.0010	Optiloc Matrix housing, titanium with attachment option	Matrix housing: titanium	4 pcs
	special accessory 2102.0003	Optiloc Retention insert red	PEEK Retention force: extra-light	4 pcs
	2102.0004	Optiloc Retention insert white	PEEK Retention force: light	4 pcs
	2102.0005	Optiloc Retention insert yellow	PEEK Retention force: medium	4 pcs
	2102.0006	Optiloc Retention insert green	PEEK Retention force: strong	4 pcs
	2102.0007	Optiloc Retention insert blue	PEEK Retention force: extra-strong	4 pcs
	special accessory 2102.0008	Optiloc Retention insert black	PEEK Retention force: ultra-strong	4 pcs
	2102.0024	Optiloc Model analogue	Aluminium	4 pcs
	2102.0012	Optiloc Forming / fixing matrix	PEEK	4 pcs
	2102.0023	Optiloc Processing spacer	POM	4 pcs
	2102.0011	Optiloc Mounting collar, silicone	Silicone	10 pcs
	3202.0002	Abutment screw driver (lab) + model analog reposition aid (blue)	Aluminium, steel	1 pc
	3202.0001	Optiloc Mounting and demounting tool for retention inserts (brown)	Aluminium, steel	1 pc
	3202.0003	Optiloc Matrix housing extractor (grey)	Aluminium, steel	1 pc

Prosthetics

Planning abutment straight

- Aluminium red coated



Implant connection	NI	NI	RI	RI	RI
Gingiva height	1.5 mm	3.0 mm	1.5 mm	3.0 mm	5.0 mm
Diameter	3.5 mm	3.5 mm	4.5 mm	4.5 mm	4.5 mm
Article No.	1-15-01	1-15-02	2-15-01	2-15-02	2-15-03

Planning abutment angled 18°

- Aluminium red coated
- Type 1 = angled over flat
- Type 2 = angled over corner



Implant connection	NI	NI	RI	RI	RI
Gingiva height	1.5 mm	3.0 mm	1.5 mm	3.0 mm	5.0 mm
Diameter	3.5 mm	3.5 mm	4.5 mm	4.5 mm	4.5 mm
Article No. Type 1	1-15-03	1-15-04	2-15-04	2-15-05	2-15-06
Article No. Type 2	1-15-05	1-15-06	2-15-07	2-15-08	2-15-09

Planning abutment set

- incl. storage box



Implant connection	NI
Article No.	1-15-07
Content:	1-15-01, 1-15-02, 1-15-03, 1-15-04, 1-15-05, 1-15-06

Planning abutment set

- incl. storage box



Implant connection	RI
Article No.	2-15-10
Content:	2-15-01, 2-15-02, 2-15-03, 2-15-04, 2-15-05, 2-15-06, 2-15-07, 2-15-08, 2-15-09

Prosthetic Tools

Placement instrument Hex 1.26

• Stainless steel



Version	Manual and ratchet	Manual and ratchet	Contra-angle	Contra-angle	Contra-angle
Type	short	long	extra-short	short	long
Article No.	0-13-22	0-13-23	0-13-18	0-13-04	0-13-05

Placement instrument Ball Torx

• Hardened stainless steel



Version	Manual and ratchet	Contra-angle	Contra-angle
Type			L 30 mm
Article No.	0-13-59	0-13-60	6-13-06

Suitable for: **Novaloc abutment angled, titanium base ASC Flex**

Placement instrument MedentiLOC abutment, angled

• Stainless steel
• Ball Hex



Version	Manual and ratchet	Contra-angle
Article No.	0-13-38	0-13-39

Placement instrument Optiloc abutment

• Stainless steel



Version	Manual and ratchet	Contra-angle
Article No.	0-13-61	0-13-82

Placement instrument MedentiBASE abutment

• Stainless steel



Version	Manual and ratchet
Article No.	0-13-37

Prosthetic Tools

Placement instrument Multi-unit abutment straight

- Stainless steel



Version

Manual and ratchet

Article No.

0-13-76

Torque ratchet

- with infinitely variable torque setting
- 10-40 Ncm
- Hardened stainless steel



Article No.

0-13-28

Torque ratchet surgical

- with service instrument
- Hardened stainless steel



Article No.

6-13-05

Ratchet surgical

- Hardened stainless steel



Article No.

6-13-01

Torque control device

- Hardened stainless steel



Article No.

6-13-02

Service instrument

- Hardened stainless steel



Article No.

6-13-03

Prosthetic Tools

ISO shank adapter

- Ratchet 0-13-28
- Hardened stainless steel



Article No.

0-13-50

Altus gingiva gauge



Article No.

2013.901

Prosthetic tray

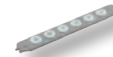

Article No.

0-13-84

Fits part number 0-13-81, extension 6-fold

Prosthetic tray

- sterilisable



Article No.

0-13-81

Tray Eco

- sterilisable
- incl. silicone pad



Article No.

0-13-51

Prosthetic tray Eco

- sterilisable
- incl. ratchet 0-13-28
- incl. placement instrument Hex 1.26 0-13-22



Article No.

0-13-52

Accessories

MedentiLOC screw patrix Bars

- Titanium Grade 5 CF
- TiN coated
- M 2.0
- Recommended torque: 35 Ncm



Article No.

2000

Please note: To screw in the MedentiLOC screw patrix you need the Placement instrument hex 2,00 mm M 11-10.

Novaloc screw patrix Bars

- Titanium Grade 5 CF
- ADLC coated
- M 2.0
- Recommended torque: 35 Ncm



Article No.

6000

Please note: To screw in the Novaloc screw patrix you need the Placement instrument hex 2,00 mm M 11-10.

Optiloc screw patrix Bars

- Titanium Grade 5 CF
- ADLC coated
- M 2.0
- Recommended torque: 35 Ncm



Article No.

5000

Please note: To screw in the straight Optiloc abutments you need the special Placement instrument 0-13-61 / 0-13-82

X-ray foils MICROCONE



Article No.

0-24-13

Dental implant pass



Article No.

PM06_02_0003



Publisher

Medentika® GmbH

Date: May 2021

We are certified according to:

DIN EN ISO 13485

Medical Devices Directive 93/42/EEC

CE 0483

The electronic Instructions for Use for our products are available on the website www.medentika.com/ifu

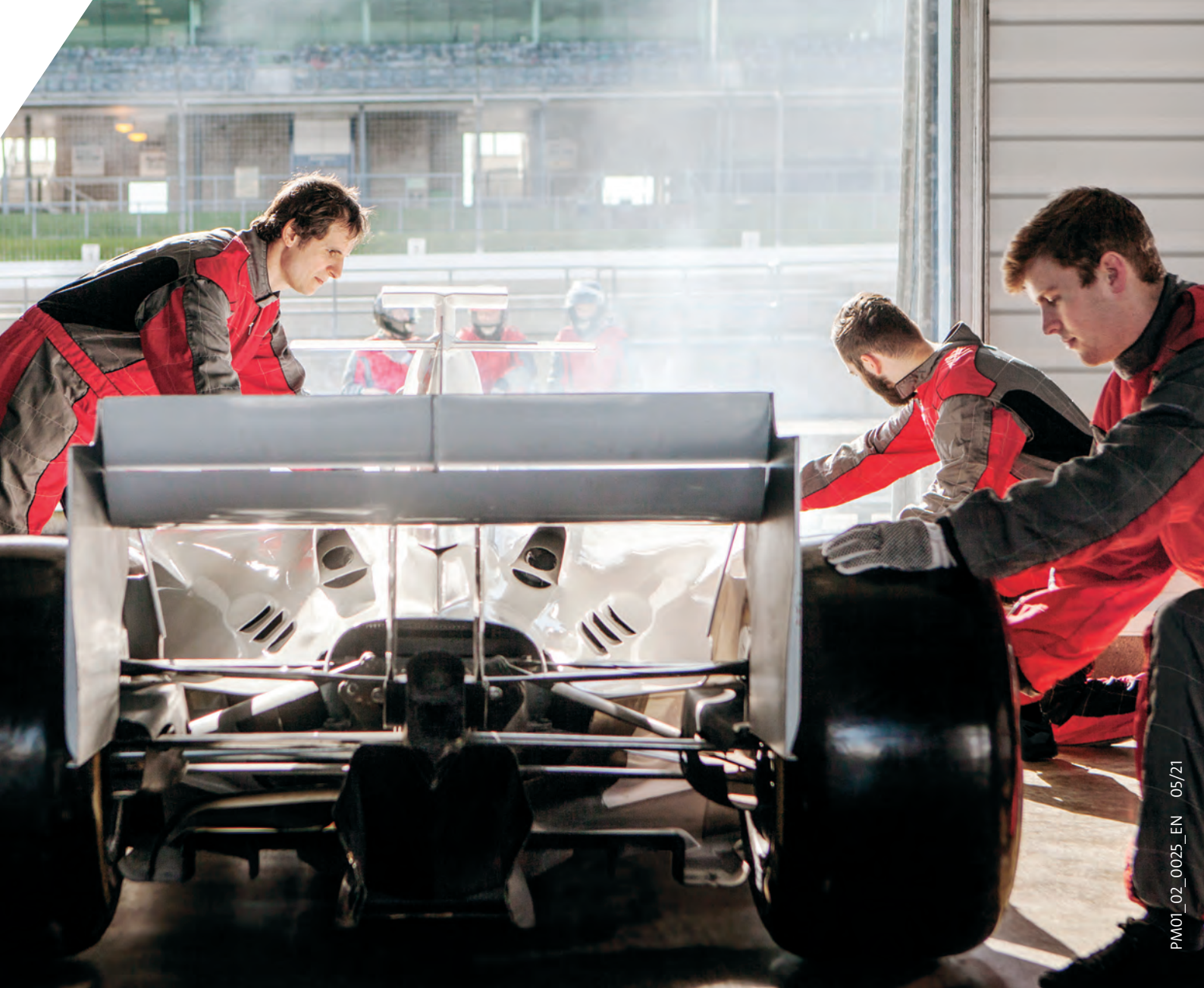

PM01_02_0025_EN 05/21

» Passion for Precision «

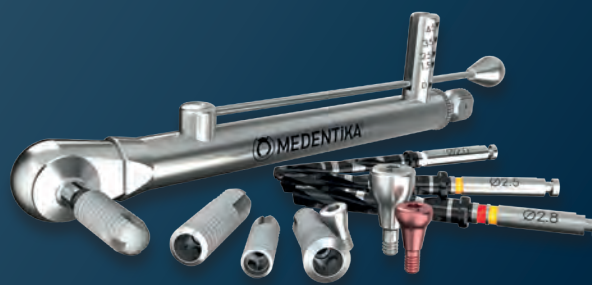

Medentika® GmbH
Hammweg 8–10
76549 Hügelshiem
info@medentika.de
www.medentika.com

© Medentika® GmbH, 2021. All rights reserved.
Medentika® and/or other trademarks and logos from Medentika® mentioned herein are the trademarks or registered trademarks of Medentika® and/or its affiliates.

 **MEDENTIKA®**
A Straumann Group Brand